

GUIDE RAPIDE POUR DEVIS

ÉLÉMENTS BAS

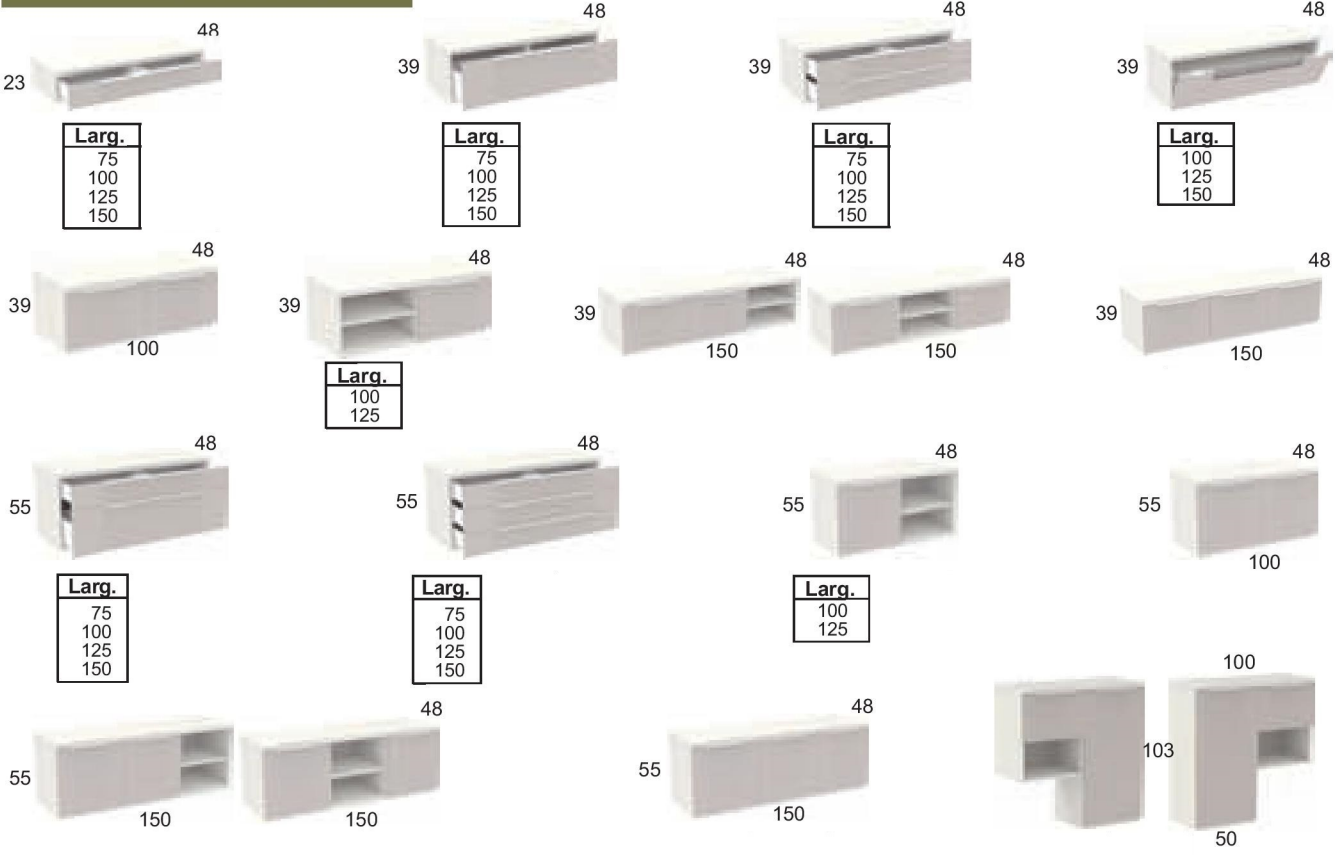

ÉLÉMENTS MODULABLES

REQUIERT PLATEAU

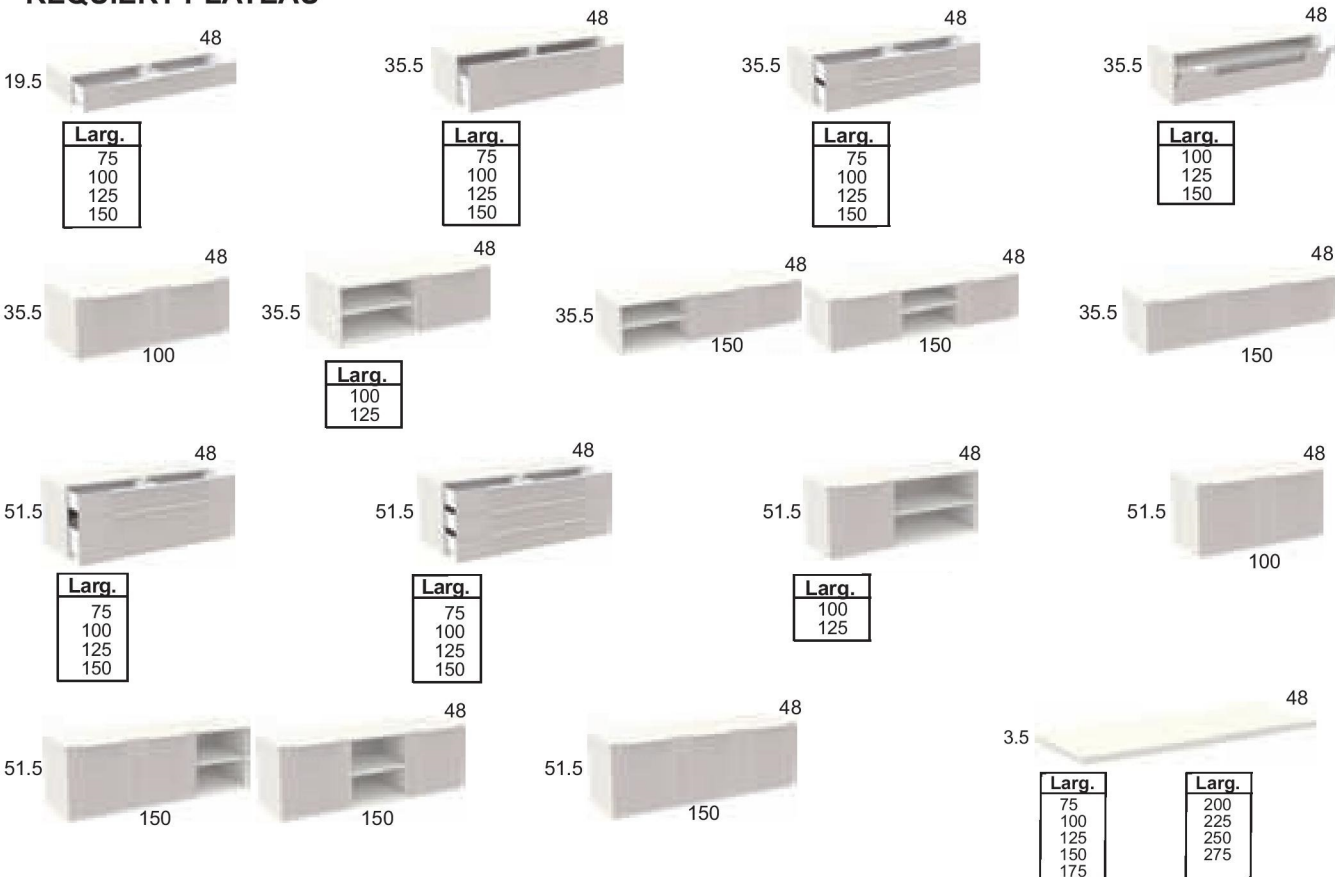

DÉCOUPES SPÉCIALES

ÉLÉMENTS BAS AVEC PORTES ET TIROIRS – VITRINES – ÉLÉMENTS HAUTS

DÉCOUPE FOND

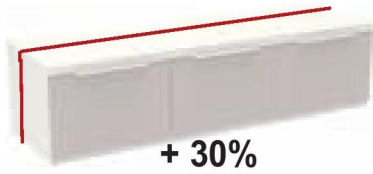

DÉCOUPE LARGEUR
(Sauf contour aluminium)



DÉCOUPE HAUTEUR
(Sauf contour aluminium)

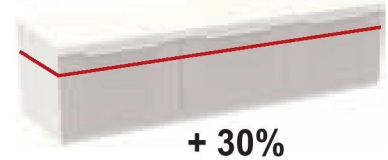

DÉCOUPE
COLONNE OU PILIER



COMBINAISON DE 2 DÉCOUPES

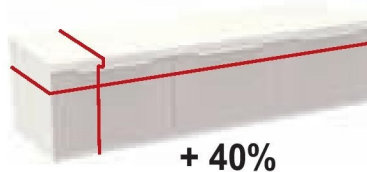

BUFFETS

DÉCOUPE FOND

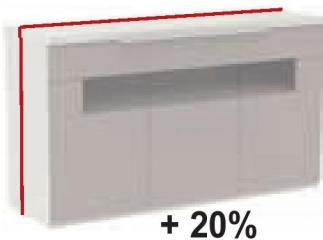

DÉCOUPE LARGEUR
(Sauf contour aluminium)

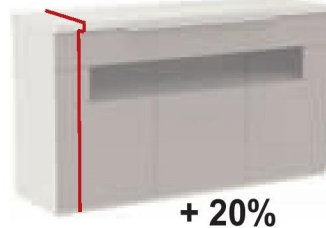

DÉCOUPE HAUTEUR
(Sauf contour aluminium)

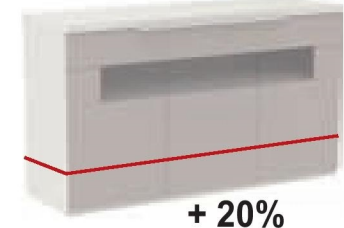

DÉCOUPE
COLONNE OU PILIER

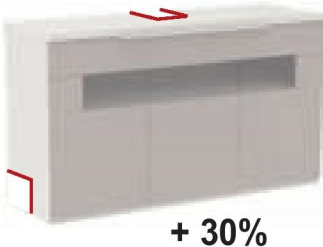

COMBINAISON DE 2 DÉCOUPES

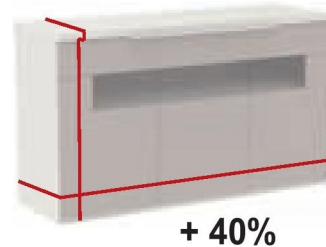

SUPPORTS TV, MODULE TV PLASMA PLATEAUX, ÉTAGÈRES ET PORTES

DÉCOUPE LARGEUR

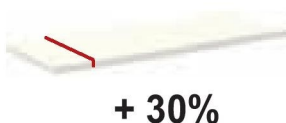

2 DÉCOUPE
OU DÉCROCHAGE

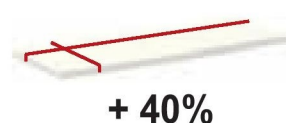

Requiert croquis avec les dimensions de la découpe à réaliser.

**POUR TOUTE AUTRE DÉCOUPE SPÉCIALE, CONSULTEZ.
PAS DE REPRISE D'ÉLÉMENT AYANT SUBI UNE DÉCOUPE SPECIALE**

GUIDE RAPIDE POUR DEVIS

PIEDS ET ILLUMINATION

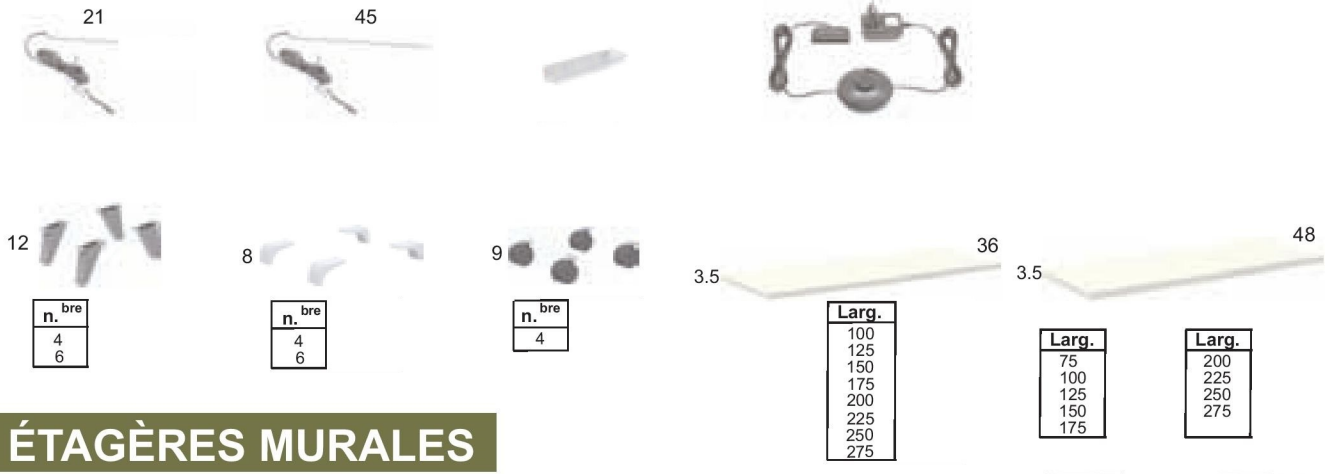

ÉTAGÈRES MURALES

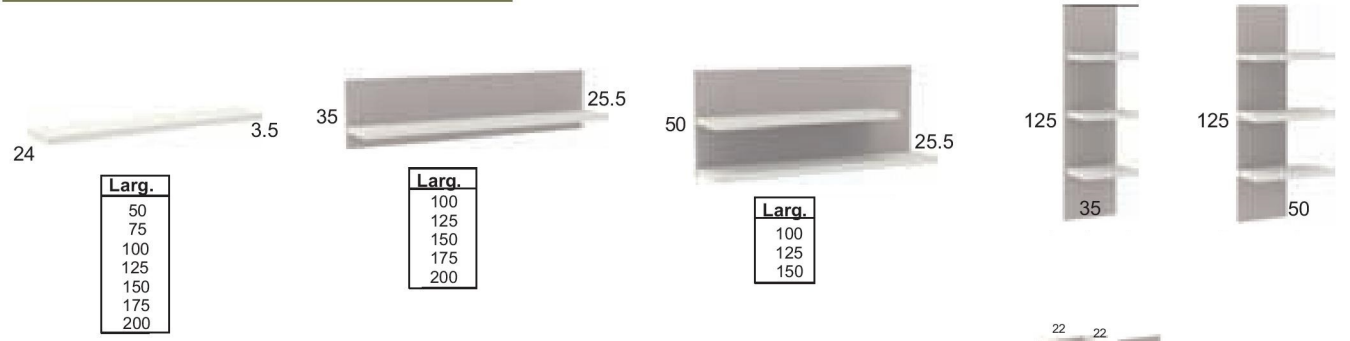

BUFFETS

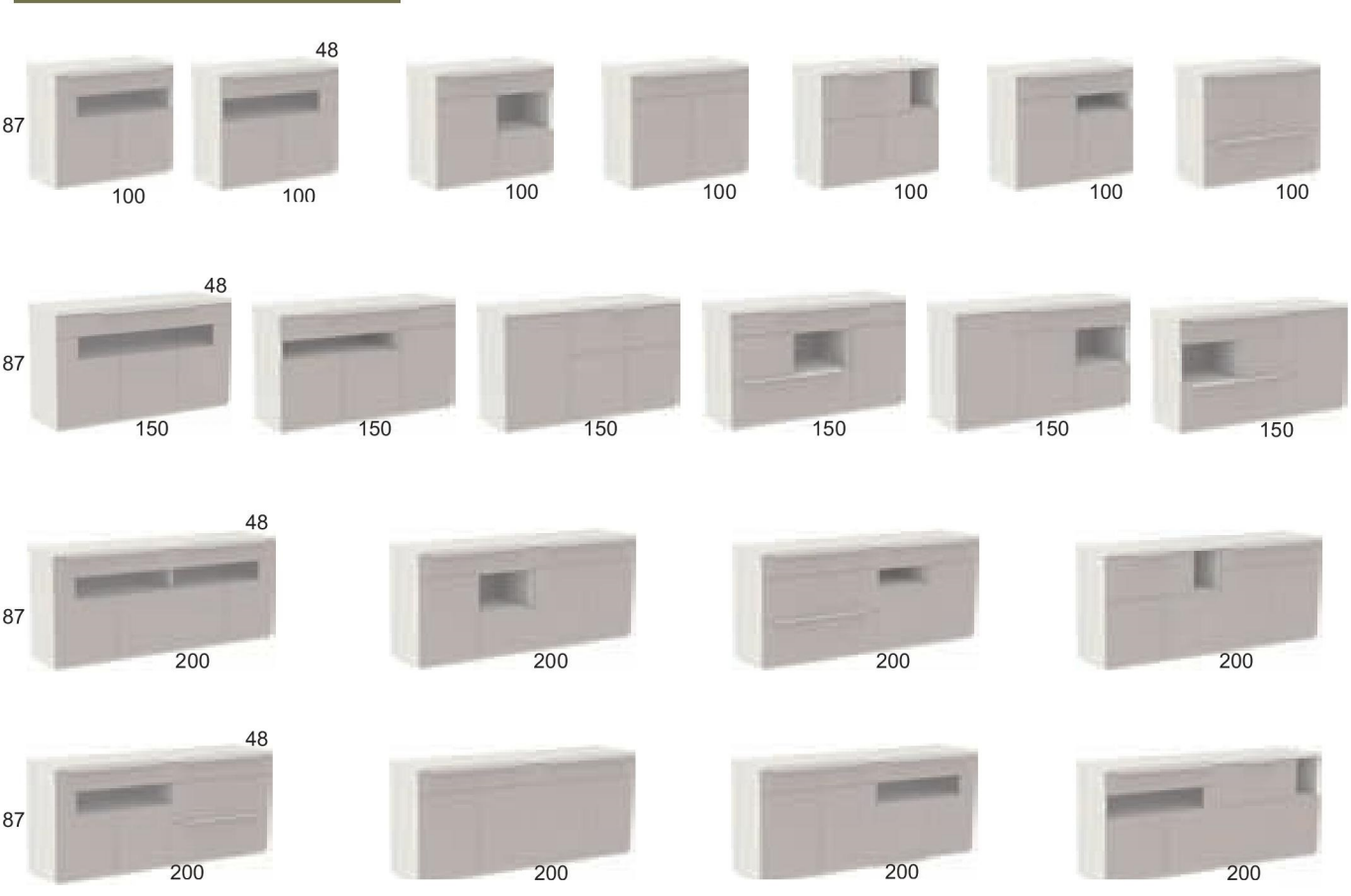

TABLES SALLE À MANGER

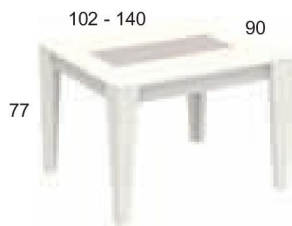

Larg.	Pann.	Verre
102		
140		



Larg.	Pann.	Verre
160		
200		



Larg.	Pann.	Verre
102		
140		



Larg.	Pann.	Verre
160		
200		

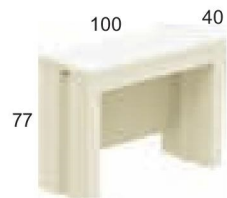

Pann.	Verre



Larg.	Pann.	Verre
160		
200		

CHAISES



TABLES BASSES



Pann.	Verre



Pann.	Verre



Pann.	Verre

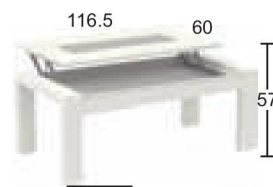

Pann.	Verre

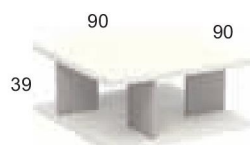
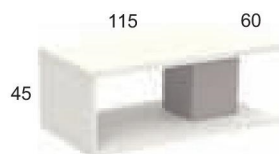



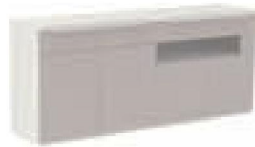
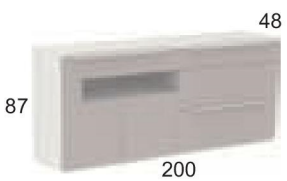
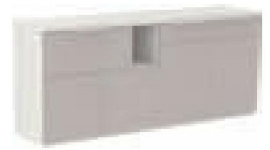
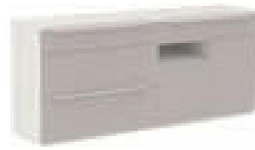
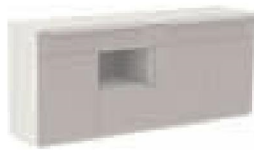
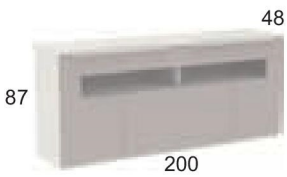
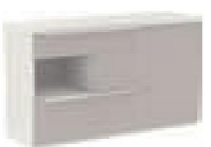
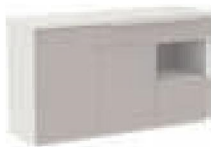
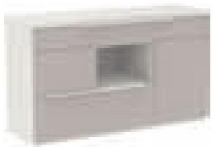
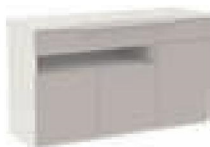
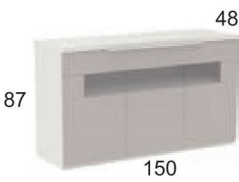
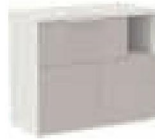
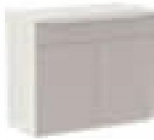
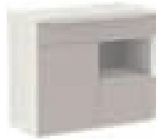
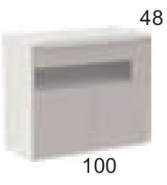
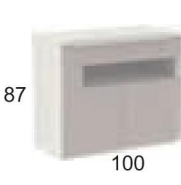
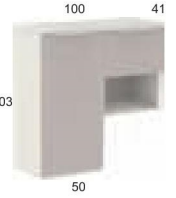
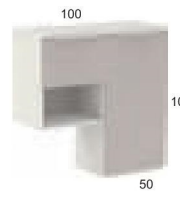
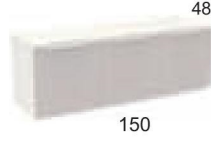
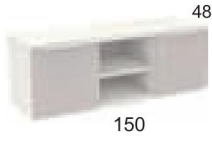
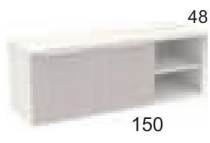
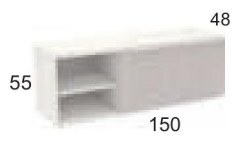
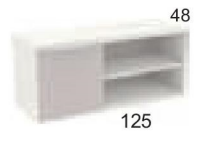
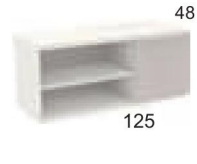
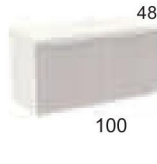
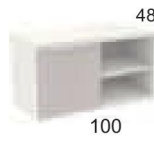
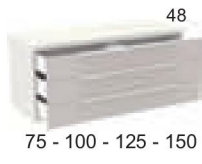
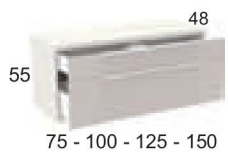
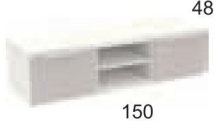
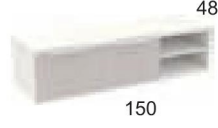
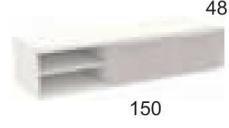
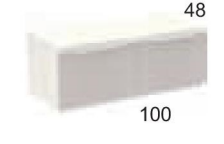
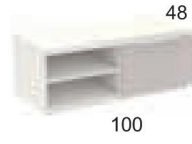
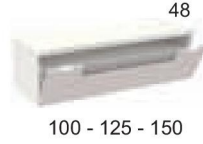
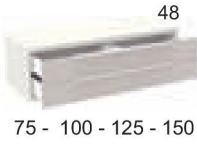
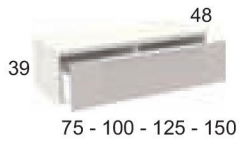

ÉLÉMENTS BAS - TV





ÉLÉMENTS BAS 1 TIROIR

Coulisses occultes avec amortisseurs

DIMENSIONS	REF.	DESCRIPTION	COULEUR STRUCT.	COULEUR FAÇADE	POINTS
 <p>23 48 75</p>	U50010	Élément bas 1 tiroir 75	BLANC ALASKA OSLO CHÊNE CAVIAR	BLANC ALASKA OSLO CHÊNE CAVIAR CIMENT MAR ONIX	
 <p>23 48 100</p>	U50011	Élément bas 1 tiroir 100	BLANC ALASKA OSLO CHÊNE CAVIAR	BLANC ALASKA OSLO CHÊNE CAVIAR CIMENT MAR ONIX	
 <p>23 48 125</p>	U50012	Élément bas 1 tiroir 125	BLANC ALASKA OSLO CHÊNE CAVIAR	BLANC ALASKA OSLO CHÊNE CAVIAR CIMENT MAR ONIX	
 <p>23 48 150</p>	U50013	Élément bas 1 tiroir 150	BLANC ALASKA OSLO CHÊNE CAVIAR	BLANC ALASKA OSLO CHÊNE CAVIAR CIMENT MAR ONIX	



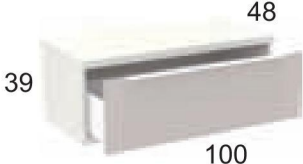

ÉLÉMENTS BAS 1 CONTAINER

Coulisses occultes avec amortisseurs

DIMENSIONS	REF.	DESCRIPTION	COULEUR STRUCT.	COULEUR FAÇADE	POINTS
 <p>39 48 75</p>	U50030	Élément bas cont. 75	BLANC ALASKA OSLO CHÊNE CAVIAR	BLANC ALASKA OSLO CHÊNE CAVIAR CIMENT MAR ONIX	
 <p>39 48 100</p>	U50031	Élément bas cont. 100	BLANC ALASKA OSLO CHÊNE CAVIAR	BLANC ALASKA OSLO CHÊNE CAVIAR CIMENT MAR ONIX	
 <p>39 48 125</p>	U50032	Élément bas cont. 125	BLANC ALASKA OSLO CHÊNE CAVIAR	BLANC ALASKA OSLO CHÊNE CAVIAR CIMENT MAR ONIX	
 <p>39 48 150</p>	U50033	Élément bas cont. 150	BLANC ALASKA OSLO CHÊNE CAVIAR	BLANC ALASKA OSLO CHÊNE CAVIAR CIMENT MAR ONIX	

ÉLÉMENTS BAS 2 TIROIRS

Coulisses occultes avec amortisseurs

DIMENSIONS	REF.	DESCRIPTION	COULEUR STRUCT.	COULEUR FAÇADE	POINTS
 <p>39 48 75</p>	U50050	Élément bas 2 tiroirs 75	BLANC ALASKA OSLO CHÊNE CAVIAR	BLANC ALASKA OSLO CHÊNE CAVIAR CIMENT MAR ONIX	
 <p>39 48 100</p>	U50051	Élément bas 2 tiroirs 100	BLANC ALASKA OSLO CHÊNE CAVIAR	BLANC ALASKA OSLO CHÊNE CAVIAR CIMENT MAR ONIX	
 <p>39 48 125</p>	U50052	Élément bas 2 tiroirs 125	BLANC ALASKA OSLO CHÊNE CAVIAR	BLANC ALASKA OSLO CHÊNE CAVIAR CIMENT MAR ONIX	
 <p>39 48 150</p>	U50053	Élément bas 2 tiroirs 150	BLANC ALASKA OSLO CHÊNE CAVIAR	BLANC ALASKA OSLO CHÊNE CAVIAR CIMENT MAR ONIX	

ÉLÉMENTS BAS VIDÉO / P.ABATTANTE

Portes montées sur la structure



DIMENSIONS	REF.	DESCRIPTION	COULEUR STRUCT	COULEUR FAÇADE	POINTS
 <p>39 48 100</p> <p>Porte abattante</p> <p>Verre fumé</p>	U50071	Élément bas vidéo-abattante 100	BLANC ALASKA OSLO CHÊNE CAVIAR	BLANC ALASKA OSLO CHÊNE CAVIAR CIMENT MAR ONIX	
 <p>39 48 125</p> <p>Porte abattante</p> <p>Verre fumé</p>	U50072	Élément bas vidéo-abattante 125	BLANC ALASKA OSLO CHÊNE CAVIAR	BLANC ALASKA OSLO CHÊNE CAVIAR CIMENT MAR ONIX	
 <p>39 48 150</p> <p>Porte abattante</p> <p>Verre fumé</p>	U50073	Élément bas vidéo-abattante 150	BLANC ALASKA OSLO CHÊNE CAVIAR	BLANC ALASKA OSLO CHÊNE CAVIAR CIMENT MAR ONIX	

Note : Découpes SPÉCIALES page 3

Définir la couleur de la poignée (par défaut couleur alu)

ÉLÉMENTS BAS VIDÉO / PORTE

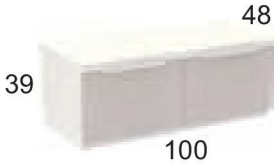
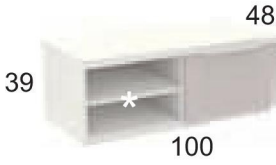
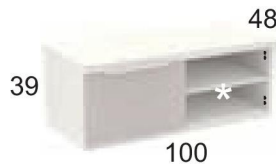
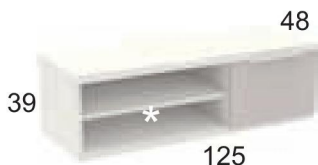
Portes montées sur la structure

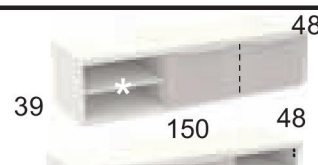
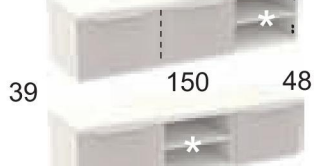
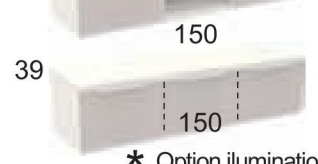

DIMENSIONS	REF.	DESCRIPTION	COULEUR STRUCT.	COULEUR FAÇADE	POINTS
 <p>39 48 100</p>	U50090	Éléments bas portes 100	BLANC ALASKA OSLO CHÊNE CAVIAR	BLANC ALASKA OSLO CHÊNE CAVIAR CIMENT MAR ONIX	
 <p>39 48 100</p> <p>* Option illumination Pag. 60</p>  <p>39 48 100</p>	U50091 U50092	Élém. bas vidéo/porte 100 Droite Élém. bas vidéo/porte 100 Gauche	BLANC ALASKA OSLO CHÊNE CAVIAR	BLANC ALASKA OSLO CHÊNE CAVIAR CIMENT MAR ONIX	
 <p>39 48 125</p> <p>* Option illumination Pag. 60</p>  <p>39 48 125</p>	U50093 U50094	Élém. bas vidéo/porte 125 Droite Élém. bas vidéo/porte 125 Gauche	BLANC ALASKA OSLO CHÊNE CAVIAR	BLANC ALASKA OSLO CHÊNE CAVIAR CIMENT MAR ONIX	
 <p>39 48 150 48</p>  <p>39 48 150 48</p>  <p>39 48 150</p> <p>* Option illumination Pag. 60</p>	U50096 U50097 U50098 U50099	Élém. bas vidéo à Gauche Élém. bas vidéo à Droite Élém. bas vidéo au Centre Élém. bas vidéo 3 portes	BLANC ALASKA OSLO CHÊNE CAVIAR	BLANC ALASKA OSLO CHÊNE CAVIAR CIMENT MAR ONIX	

Note : Découpes SPÉCIALES page 3

Définir la couleur de la poignée (par défaut couleur alu) 13

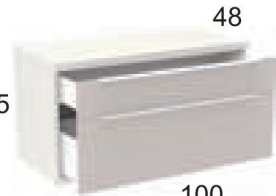

ÉLÉMENTS BAS TIROIR-CONTAINER

Coulisses occultes avec amortisseurs

DIMENSIONS	REF.	DESCRIPTION	COULEUR STRUCT.	COULEUR FAÇADE	POINTS
 <p>55 48 75</p>	U50210	Élém. bas tir.+cont. 75	BLANC ALASKA OSLO CHÊNE CAVIAR	BLANC ALASKA OSLO CHÊNE CAVIAR CIMENT MAR ONIX	
 <p>55 48 100</p>	U50211	Élém. bas tir.+cont. 100	BLANC ALASKA OSLO CHÊNE CAVIAR	BLANC ALASKA OSLO CHÊNE CAVIAR CIMENT MAR ONIX	
 <p>55 48 125</p>	U50212	Élém. bas tir.+cont. 125	BLANC ALASKA OSLO CHÊNE CAVIAR	BLANC ALASKA OSLO CHÊNE CAVIAR CIMENT MAR ONIX	
 <p>55 48 150</p>	U50213	Élém. bas tir.+cont. 150	BLANC ALASKA OSLO CHÊNE CAVIAR	BLANC ALASKA OSLO CHÊNE CAVIAR CIMENT MAR ONIX	

ÉLÉMENTS BAS 3 TIROIRS

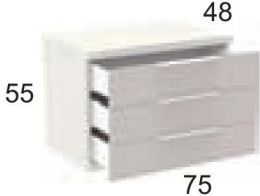
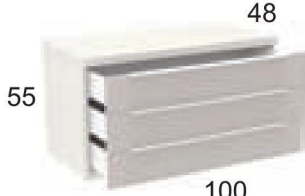
Coulisses occultes avec amortisseurs

DIMENSIONS	REF.	DESCRIPTION	COULEUR STRUCT.	COULEUR FAÇADE	POINTS
 <p>55 48 75</p>	U50230	Élément bas 3 tiroirs 75	BLANC ALASKA OSLO CHÊNE CAVIAR	BLANC ALASKA OSLO CHÊNE CAVIAR CIMENT MAR ONIX	
 <p>55 48 100</p>	U50231	Élément bas 3 tiroirs 100	BLANC ALASKA OSLO CHÊNE CAVIAR	BLANC ALASKA OSLO CHÊNE CAVIAR CIMENT MAR ONIX	
 <p>55 48 125</p>	U50232	Élément bas 3 tiroirs 125	BLANC ALASKA OSLO CHÊNE CAVIAR	BLANC ALASKA OSLO CHÊNE CAVIAR CIMENT MAR ONIX	
 <p>55 48 150</p>	U50233	Élément bas 3 tiroirs 150	BLANC ALASKA OSLO CHÊNE CAVIAR	BLANC ALASKA OSLO CHÊNE CAVIAR CIMENT MAR ONIX	

ÉLÉMENTS BAS VIDÉO / PORTE

Portes montées sur la structure

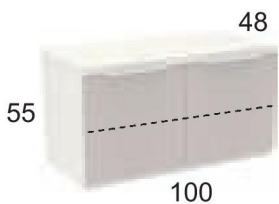
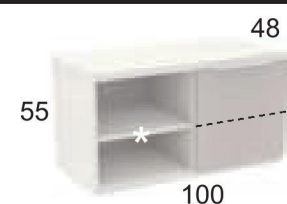
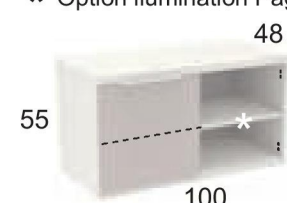
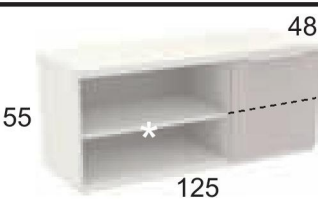
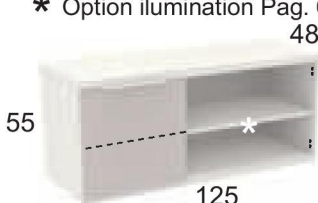
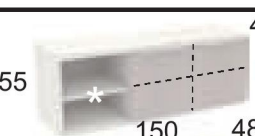
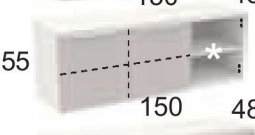
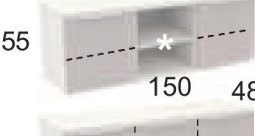
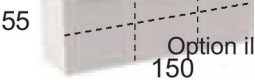
DIMENSIONS	REF.	DESCRIPTION	COULEUR STRUCT.	COULEUR FAÇADE	POINTS
 <p>55 48 100</p>	U50290	Éléments bas portes 100	BLANC ALASKA OSLO CHÊNE CAVIAR	BLANC ALASKA OSLO CHÊNE CAVIAR CIMENT MAR ONIX	
 <p>55 48 100</p> <p>* Option illumination Pag. 60</p>	U50291	Élém. bas vidéo/porte 100 Droite	BLANC ALASKA OSLO CHÊNE CAVIAR	BLANC ALASKA OSLO CHÊNE CAVIAR CIMENT MAR ONIX	
 <p>55 48 100</p>	U50292	Élém. bas vidéo/porte 100 Gauche	BLANC ALASKA OSLO CHÊNE CAVIAR	BLANC ALASKA OSLO CHÊNE CAVIAR CIMENT MAR ONIX	
 <p>55 48 125</p> <p>* Option illumination Pag. 60</p>	U50293	Élém. bas vidéo/porte 125 Droite	BLANC ALASKA OSLO CHÊNE CAVIAR	BLANC ALASKA OSLO CHÊNE CAVIAR CIMENT MAR ONIX	
 <p>55 48 125</p>	U50294	Élém. bas vidéo/porte 125 Gauche	BLANC ALASKA OSLO CHÊNE CAVIAR	BLANC ALASKA OSLO CHÊNE CAVIAR CIMENT MAR ONIX	
 <p>55 48 150</p>	U50296	Élém. bas vidéo à Gauche		BLANC ALASKA OSLO CHÊNE CAVIAR CIMENT MAR ONIX	
 <p>55 48 150</p>	U50297	Élém. bas vidéo à Droite	BLANC ALASKA OSLO CHÊNE CAVIAR	BLANC ALASKA OSLO CHÊNE CAVIAR CIMENT MAR ONIX	
 <p>55 48 150</p>	U50298	Élém. bas vidéo au Centre	BLANC ALASKA OSLO CHÊNE CAVIAR	BLANC ALASKA OSLO CHÊNE CAVIAR CIMENT MAR ONIX	
 <p>55 48 150</p> <p>* Option illumination Pag: 60</p>	U50299	Élém. bas vidéo 3 portes		BLANC ALASKA OSLO CHÊNE CAVIAR CIMENT MAR ONIX	

ÉLÉMENTS BAS PORTES 100

Coulisses occultes avec amortisseurs

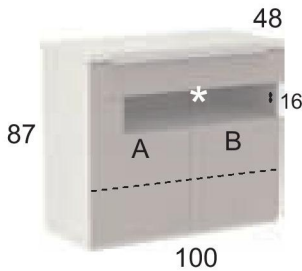
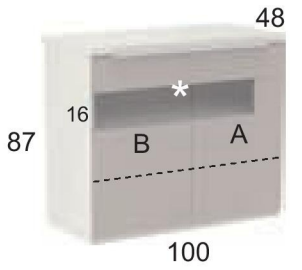
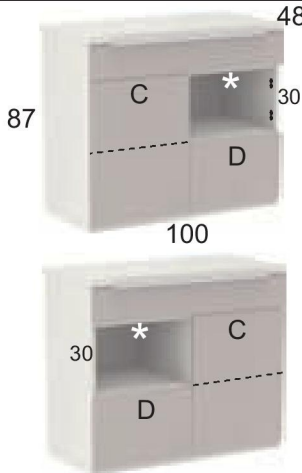
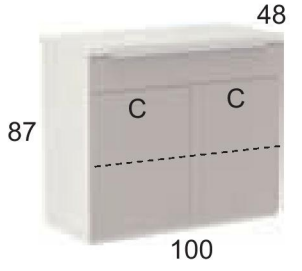
DIMENSIONS	REF.	DESCRIPTION	COULEUR STRUCT.	COULEUR FAÇADE	POINTS
 <p>* Option illumination Pag. 60</p>	U50500	<p>Buffet portes verre Gauche</p> <p>Verre fumé</p>	BLANC ALASKA OSLO CHÊNE CAVIAR	BLANC ALASKA OSLO CHÊNE CAVIAR CIMENT MAR ONIX	
 <p>* Option illumination Pag. 60</p>	U50501	<p>Buffet portes verre Droite</p> <p>Verre fumé</p>			
 <p>* Option illumination Pag. 60</p>	U50510	<p>Buffet niche Gauche - Droite</p>	BLANC ALASKA OSLO CHÊNE CAVIAR	BLANC ALASKA OSLO CHÊNE CAVIAR CIMENT MAR ONIX	
	U50511	<p>Buffet Portes</p>	BLANC ALASKA OSLO CHÊNE CAVIAR	BLANC ALASKA OSLO CHÊNE CAVIAR CIMENT MAR ONIX	

ÉLÉMENTS BAS PORTES 100

Coulisses occultes avec amortisseurs

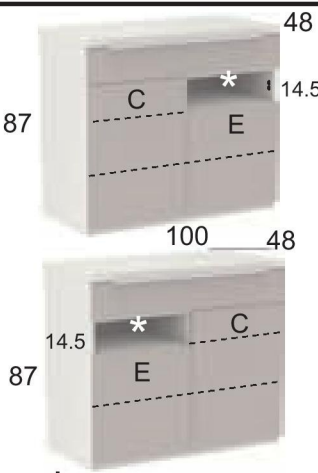
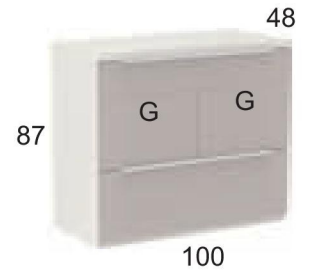
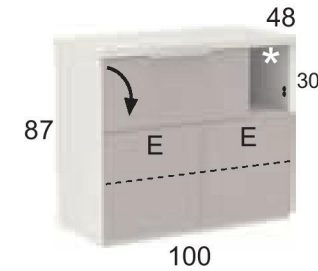
DIMENSIONS	REF.	DESCRIPTION	COULEUR STRUCT.	COULEUR FAÇADE	POINTS
 <p>* Option illumination Pag. 60</p>	U50513	Buffet petite niche Gauche - Droite	BLANC ALASKA OSLO CHÊNE CAVIAR	BLANC ALASKA OSLO CHÊNE CAVIAR CIMENT MAR ONIX	
	U50514	Buffet container	BLANC ALASKA OSLO CHÊNE CAVIAR	BLANC ALASKA OSLO CHÊNE CAVIAR CIMENT MAR ONIX	
 <p>* Option illumination Pag. 60</p>	U50512	Buffet pte abattante	BLANC ALASKA OSLO CHÊNE CAVIAR	BLANC ALASKA OSLO CHÊNE CAVIAR CIMENT MAR ONIX	

ÉLÉMENTS BAS PORTES 150

Coulisses occultes avec amortisseurs

 <p>* Option illumination Pag. 60</p>	U50502	Buffet portes verre Verre fumé	BLANC ALASKA OSLO CHÊNE CAVIAR	BLANC ALASKA OSLO CHÊNE CAVIAR CIMENT MAR ONIX	
--	---------------	---------------------------------------	--	---	--

ÉLÉMENTS BAS PORTES 150

Coulisses occultes avec amortisseurs

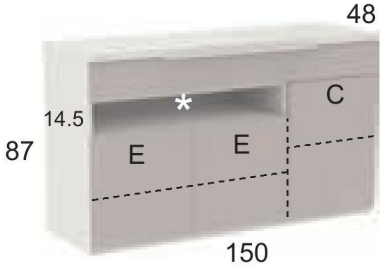
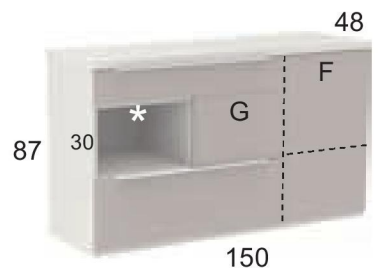
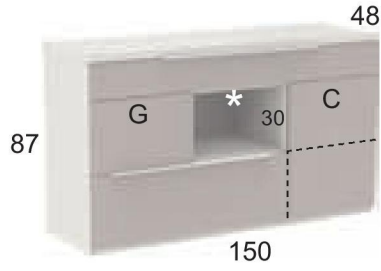
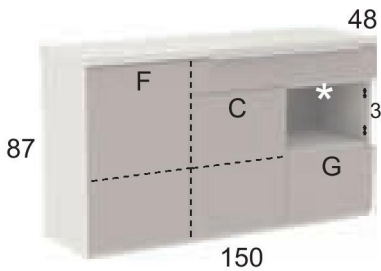
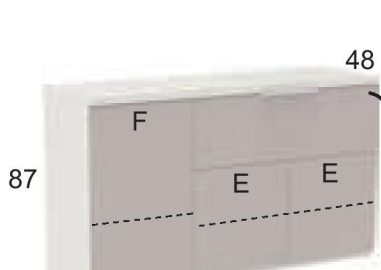
DIMENSIONS	REF.	DESCRIPTION	COULEUR STRUCT.	COULEUR FAÇADE	POINTS
 <p>87 48 14.5 * C E E 150</p> <p>* Option illumination Pag. 60</p>	U50520	Buffet petite niche	BLANC ALASKA OSLO CHÊNE CAVIAR	BLANC ALASKA OSLO CHÊNE CAVIAR CIMENT MAR ONIX	
 <p>87 48 30 * G F 150</p> <p>* Option illumination Pag. 60</p>	U50524	Buffet container	BLANC ALASKA OSLO CHÊNE CAVIAR	BLANC ALASKA OSLO CHÊNE CAVIAR CIMENT MAR ONIX	
 <p>87 48 30 * G C 150</p> <p>* Option illumination Pag. 60</p>	U50522	Buffet container	BLANC ALASKA OSLO CHÊNE CAVIAR	BLANC ALASKA OSLO CHÊNE CAVIAR CIMENT MAR ONIX	
 <p>87 48 30 * F C G 150</p> <p>* Option illumination Pag. 60</p>	U50523	Buffet niche	BLANC ALASKA OSLO CHÊNE CAVIAR	BLANC ALASKA OSLO CHÊNE CAVIAR CIMENT MAR ONIX	
 <p>87 48 F E E 150</p>	U50521	Buffet pte abattante	BLANC ALASKA OSLO CHÊNE CAVIAR	BLANC ALASKA OSLO CHÊNE CAVIAR CIMENT MAR ONIX	

ÉLÉMENTS BAS PORTES 200

Coulisses occultes avec amortisseurs

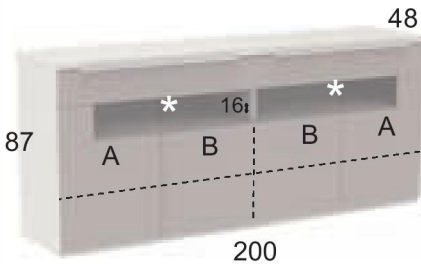
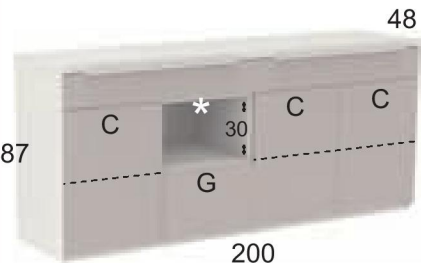
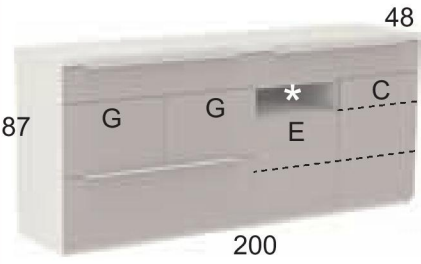
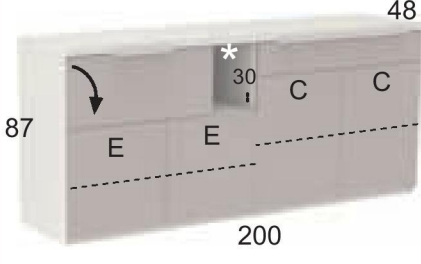
DIMENSIONS	REF.	DESCRIPTION	COULEUR STRUCT.	COULEUR FAÇADE	POINTS
 <p>87 48 160 200</p> <p>A B B A</p> <p>* Option illumination Pag. 60</p>	U50503	Buffet portes verre Verre fumé	BLANC ALASKA OSLO CHÊNE CAVIAR	BLANC ALASKA OSLO CHÊNE CAVIAR CIMENT MAR ONIX	
 <p>87 48 30 200</p> <p>C C C G</p> <p>* Option illumination Pag. 60</p>	U50580	Buffet niche + portes	BLANC ALASKA OSLO CHÊNE CAVIAR	BLANC ALASKA OSLO CHÊNE CAVIAR CIMENT MAR ONIX	
 <p>87 48 30 200</p> <p>G G E C</p> <p>* Option illumination Pag. 60</p>	U50581	Buffet niche + cont.	BLANC ALASKA OSLO CHÊNE CAVIAR	BLANC ALASKA OSLO CHÊNE CAVIAR CIMENT MAR ONIX	
 <p>87 48 30 200</p> <p>E E C C</p> <p>* Option illumination Pag. 60</p>	U50582	Buffet pte abatt. + portes	BLANC ALASKA OSLO CHÊNE CAVIAR	BLANC ALASKA OSLO CHÊNE CAVIAR CIMENT MAR ONIX	

ÉLÉMENTS BAS PORTES 200

Coulisses occultes avec amortisseurs

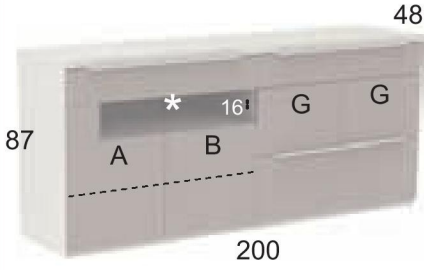
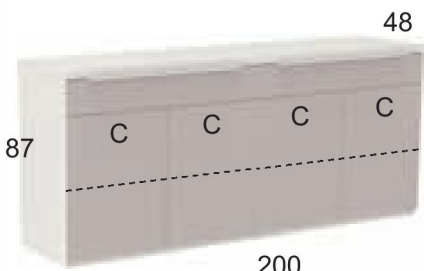
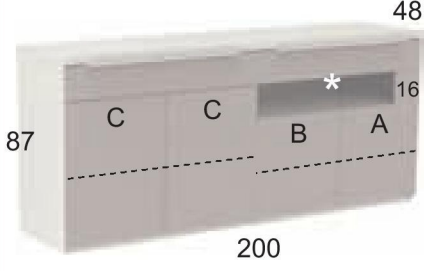
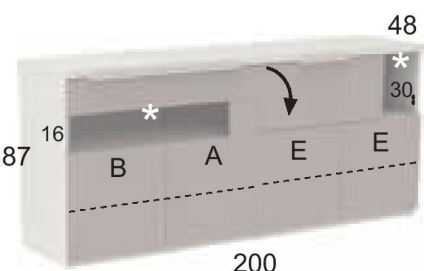
DIMENSIONS	REF.	DESCRIPTION	COULEUR STRUCT.	COULEUR FAÇADE	POINTS
 <p>87 48 * 16 G G A B 200</p> <p>* Option illumination Pag. 60</p>	U50583	Buffet portes verre / cont. Verre fumé	BLANC ALASKA OSLO CHÊNE CAVIAR	BLANC ALASKA OSLO CHÊNE CAVIAR CIMENT MAR ONIX	
 <p>87 48 C C C C 200</p>	U50584	Buffet portes + portes	BLANC ALASKA OSLO CHÊNE CAVIAR	BLANC ALASKA OSLO CHÊNE CAVIAR CIMENT MAR ONIX	
 <p>87 48 C C * 16 B A 200</p> <p>* Option illumination Pag. 60</p>	U50585	Buffet portes + ptes verre Verre fumé	BLANC ALASKA OSLO CHÊNE CAVIAR	BLANC ALASKA OSLO CHÊNE CAVIAR CIMENT MAR ONIX	
 <p>87 48 * 16 * 30 B A E E 200</p> <p>* Option illumination Pag. 60</p>	U50586	Buffet ptes verre + pte abatt Verre fumé	BLANC ALASKA OSLO CHÊNE CAVIAR	BLANC ALASKA OSLO CHÊNE CAVIAR CIMENT MAR ONIX	

PLUS DE BUFFETS EN 200 ET 250, SECTION BUFFET MODULABLES PAG. 33 à 36

SUR-ÉLÉMENT ET SUPPORTS USB

DIMENSIONS	REF.	DESCRIPTION	COULEUR STRUCT.	COULEUR FAÇADE	POINTS
	U50325	Sur-élément pour élément bas en 39 Gauche - Droite	BLANC ALASKA OSLO CHÊNE CAVIAR	BLANC ALASKA OSLO CHÊNE CAVIAR CIMENT MAR ONIX	

<p>75 - 100 - 125 - 150 - 175 200 - 225 - 250 - 275</p>	U50331	Support 75 gch/dte (avec USB)	BLANC ALASKA OSLO CHÊNE CAVIAR	
	U50333	Support 100 gch/dte (avec USB)		
	U50335	Support 125 gch/dte (avec USB)		
	U50337	Support 150 gch/dte (avec USB)		
	U50339	Support 175 gch/dte (avec USB)		
	U50341	Support 200 gch/dte (avec USB)		
	U50343	Support 225 gch/dte (avec USB)		
	U50345	Support 250 gch/dte (avec USB)		
	U50347	Support 275 gch/dte (avec USB)		

SUPPLÉMENT TV.

DIMENSIONS	REF.	DESCRIPTION	ÉTAGÈRE	PANNEAU	POINTS
	U50300 U50301	Module T.V. plasma Module T.V. plasma (avec leds)	BLANC ALASKA OSLO CHÊNE CAVIAR	BLANC ALASKA OSLO CHÊNE CAVIAR MARMOL	
	U50309 U50310	Supplément TV. 125 Supplément TV. 150		BLANC ALASKA OSLO CHÊNE CAVIAR	
	U50311 U50312 U50313	Supplément TV. 150 Supplément TV. 200 Supplément TV. 254		BLANC ALASKA OSLO CHÊNE CAVIAR	
	U50317 U50318 U50319	Supplément TV. 150 (sur élém. bas haut. 39) Supplément TV. 200 (sur élém. bas haut. 39) Supplément TV. 254 (sur élém. bas haut. 39)		BLANC ALASKA OSLO CHÊNE CAVIAR	
 <p>* Option illumination Pag. 60</p>	U50320	Supplément TV avec niche Gauche ó Droite		BLANC ALASKA OSLO CHÊNE CAVIAR	



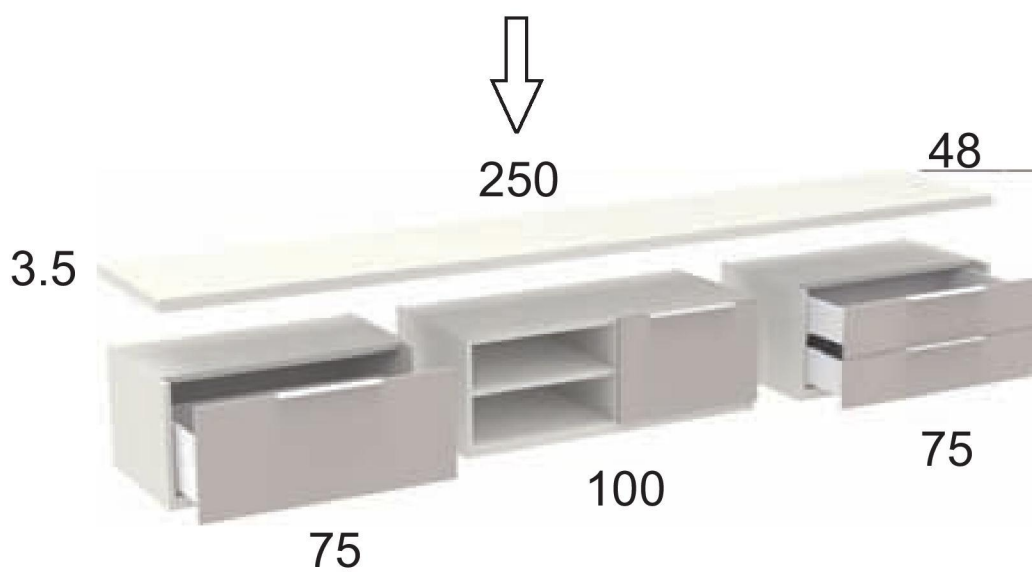
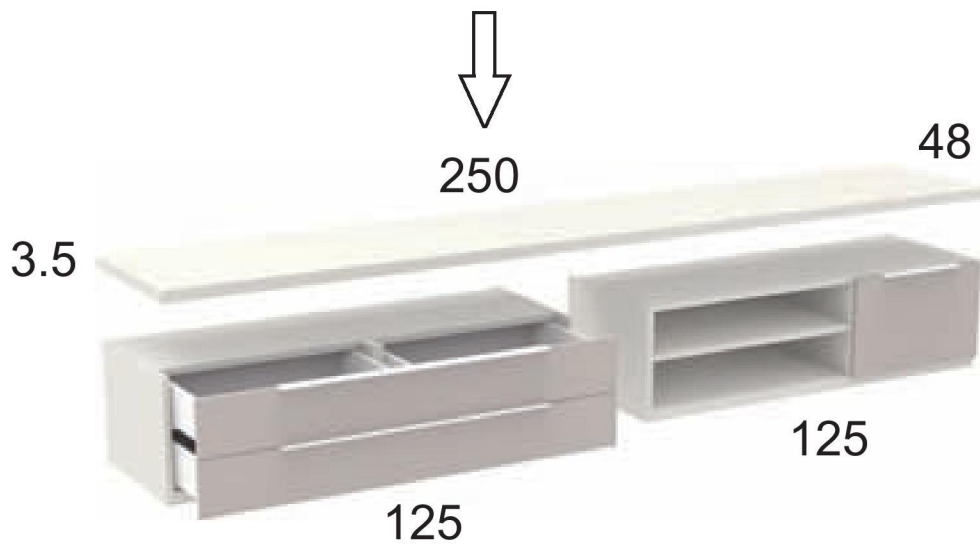

ÉLÉMENTS BAS (MODULABLES) – TV

EXEMPLES (Modulables)



ÉLÉMENTS BAS 1 TIROIR (Modulables)



Coulisses occultes avec amortisseurs

DIMENSIONS	REF.	DESCRIPTION	COULEUR STRUCT.	COULEUR FAÇADE	POINTS
 <p>19.5 48 75</p> <p>Requiert plateau pag. 36</p>	U50000	Élément bas 1 tiroir 75 Modulable	BLANC ALASKA OSLO CHÊNE CAVIAR	BLANC ALASKA OSLO CHÊNE CAVIAR CIMENT MAR ONIX	
 <p>19.5 48 100</p> <p>Requiert plateau pag. 36</p>	U50001	Élément bas 1 tiroir 100 Modulable	BLANC ALASKA OSLO CHÊNE CAVIAR	BLANC ALASKA OSLO CHÊNE CAVIAR CIMENT MAR ONIX	
 <p>19.5 48 125</p> <p>Requiert plateau pag. 36</p>	U50002	Élément bas 1 tiroir 125 Modulable	BLANC ALASKA OSLO CHÊNE CAVIAR	BLANC ALASKA OSLO CHÊNE CAVIAR CIMENT MAR ONIX	
 <p>19.5 48 150</p> <p>Requiert plateau pag. 36</p>	U50003	Élément bas 1 tiroir 150 Modulable	BLANC ALASKA OSLO CHÊNE CAVIAR	BLANC ALASKA OSLO CHÊNE CAVIAR CIMENT MAR ONIX	

ÉLÉMENTS BAS
MODULABLES

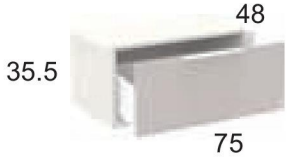
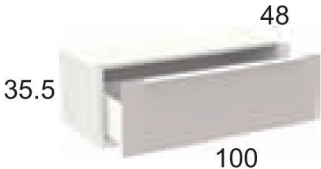

ÉLÉMENTS BAS 1 CONTANIER (Modulables)

Coulisses occultes avec amortisseurs

DIMENSIONS	REF.	DESCRIPTION	COULEUR STRUCT.	COULEUR FAÇADE	POINTS
 <p>35.5 48 75</p> <p>Requiert plateau pag. 36</p>	U50020	Élément bas container 75 Modulable	BLANC ALASKA OSLO CHÊNE CAVIAR	BLANC ALASKA OSLO CHÊNE CAVIAR CIMENT MAR ONIX	
 <p>35.5 48 100</p> <p>Requiert plateau pag. 36</p>	U50021	Élément bas container 100 Modulable	BLANC ALASKA OSLO CHÊNE CAVIAR	BLANC ALASKA OSLO CHÊNE CAVIAR CIMENT MAR ONIX	
 <p>35.5 48 125</p> <p>Requiert plateau pag. 36</p>	U50022	Élément bas container 125 Modulable	BLANC ALASKA OSLO CHÊNE CAVIAR	BLANC ALASKA OSLO CHÊNE CAVIAR CIMENT MAR ONIX	
 <p>35.5 48 150</p> <p>Requiert plateau pag. 36</p>	U50023	Élément bas container 150 Modulable	BLANC ALASKA OSLO CHÊNE CAVIAR	BLANC ALASKA OSLO CHÊNE CAVIAR CIMENT MAR ONIX	

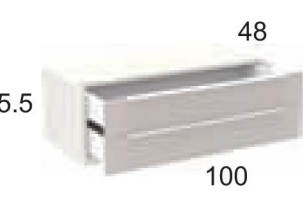

ÉLÉMENTS BAS 2 TIROIRS (Modulables)

Coulisses occultes avec amortisseurs

DIMENSIONS	REF.	DESCRIPTION	COULEUR STRUCT.	COULEUR FAÇADE	POINTS
 <p>48 35.5 75</p> <p>Requiert plateau pag. 36</p>	U50040	Élément bas 2 tiroirs 75 Modulable	BLANC ALASKA OSLO CHÊNE CAVIAR	BLANC ALASKA OSLO CHÊNE CAVIAR CIMENT MAR ONIX	
 <p>48 35.5 100</p> <p>Requiert plateau pag. 36</p>	U50041	Élément bas 2 tiroirs 100 Modulable	BLANC ALASKA OSLO CHÊNE CAVIAR	BLANC ALASKA OSLO CHÊNE CAVIAR CIMENT MAR ONIX	
 <p>48 35.5 125</p> <p>Requiert plateau pag. 36</p>	U50042	Élément bas 2 tiroirs 125 Modulable	BLANC ALASKA OSLO CHÊNE CAVIAR	BLANC ALASKA OSLO CHÊNE CAVIAR CIMENT MAR ONIX	
 <p>48 35.5 150</p> <p>Requiert plateau pag. 36</p>	U50043	Élément bas 2 tiroirs 150 Modulable	BLANC ALASKA OSLO CHÊNE CAVIAR	BLANC ALASKA OSLO CHÊNE CAVIAR CIMENT MAR ONIX	

ÉLÉM. BAS VIDÉO/ ABATTANTE (Modulables)

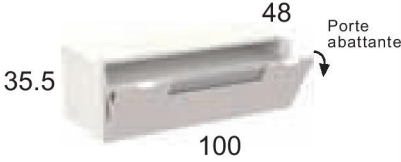
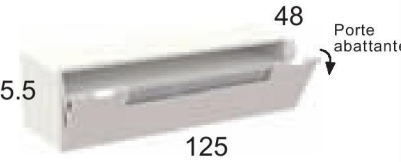
Portes montées sur la structure











DIMENSIONS	REF.	DESCRIPTION	COULEUR STRUCT.	COULEUR FAÇADE	POINTS
 <p>35.5 100 48 Porte abattante</p> <p>Requiert plateau pag. 36</p>	U50061	<p>Élément bas vidéo-abattante 100</p> <p>Modulable</p> <p>Verre fumé</p>	BLANC ALASKA OSLO CHÊNE CAVIAR	BLANC ALASKA OSLO CHÊNE CAVIAR CIMENT MAR ONIX	
 <p>35.5 125 48 Porte abattante</p> <p>Requiert plateau pag. 36</p>	U50062	<p>Élément bas vidéo-abattante 125</p> <p>Modulable</p> <p>Verre fumé</p>	BLANC ALASKA OSLO CHÊNE CAVIAR	BLANC ALASKA OSLO CHÊNE CAVIAR CIMENT MAR ONIX	
 <p>35.5 150 48 Porte abattante</p> <p>Requiert plateau pag. 36</p>	U50063	<p>Élément bas vidéo-abattante 150</p> <p>Modulable</p> <p>Verre fumé</p>	BLANC ALASKA OSLO CHÊNE CAVIAR	BLANC ALASKA OSLO CHÊNE CAVIAR CIMENT MAR ONIX	

Note : Découpes SPÉCIALES page 3

Définir la couleur de la poignée (par défaut couleur alu)

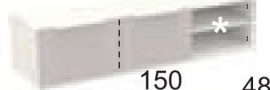

ÉLÉMENTS BAS VIDÉO / PORTE (Modulables)

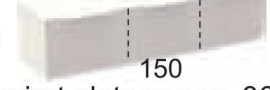
Portes montées sur la structure

DIMENSIONS	REF.	DESCRIPTION	COULEUR STRUCT.	COULEUR FAÇADE	POINTS
 <p>35.5 100 48</p> <p>Requiert plateau pag. 36</p>	U50080	Éléments bas portes 100 Modulable	BLANC ALASKA OSLO CHÊNE CAVIAR	BLANC ALASKA OSLO CHÊNE CAVIAR CIMENT MAR ONIX	
 <p>35.5 100</p> <p>* Option illumination Pag. 60</p>  <p>35.5 100 48</p> <p>Requiert plateau pag. 36</p>	U50081	Élém. bas vidéo/porte 100 Droite Modulable	BLANC ALASKA OSLO CHÊNE CAVIAR	BLANC ALASKA OSLO CHÊNE CAVIAR CIMENT MAR ONIX	
 <p>35.5 125 48</p> <p>* Option illumination Pag. 60</p>  <p>35.5 125 48</p> <p>Requiert plateau pag. 36</p>	U50083	Élém. bas vidéo/porte 125 Droite Modulable	BLANC ALASKA OSLO CHÊNE CAVIAR	BLANC ALASKA OSLO CHÊNE CAVIAR CIMENT MAR ONIX	
 <p>35.5 125 48</p> <p>* Option illumination Pag. 60</p>  <p>35.5 125 48</p> <p>Requiert plateau pag. 36</p>	U50084	Élém. bas vidéo/porte 125 Gauche Modulable	BLANC ALASKA OSLO CHÊNE CAVIAR	BLANC ALASKA OSLO CHÊNE CAVIAR CIMENT MAR ONIX	
 <p>35.5 150 48</p>	U50086	Élém. bas vidéo à Gauche Modulable		BLANC ALASKA OSLO CHÊNE CAVIAR CIMENT MAR ONIX	
 <p>35.5 150 48</p>	U50087	Élém. bas vidéo à Droite Modulable	BLANC ALASKA OSLO CHÊNE CAVIAR	BLANC ALASKA OSLO CHÊNE CAVIAR CIMENT MAR ONIX	
 <p>35.5 150 48</p>	U50088	Élém. bas vidéo au Centre Modulable	BLANC ALASKA OSLO CHÊNE CAVIAR	BLANC ALASKA OSLO CHÊNE CAVIAR CIMENT MAR ONIX	
 <p>35.5 150</p> <p>Requiert plateau pag. 36</p>	U50089	Élém. bas vidéo 3 portes Modulable		BLANC ALASKA OSLO CHÊNE CAVIAR CIMENT MAR ONIX	

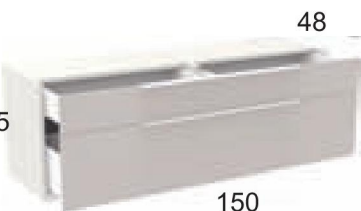

ÉLÉMENTS BAS TIROIR-CONT. (Modulables)

Coulisses occultes avec amortisseurs

DIMENSIONS	REF.	DESCRIPTION	COULEUR STRUCT.	COULEUR FAÇADE	POINTS
 <p>51.5</p> <p>48</p> <p>75</p> <p>Requiert plateau pag. 36</p>	U50200	Élém. bas tir.+cont. 75 Modulable	BLANC ALASKA OSLO CHÊNE CAVIAR	BLANC ALASKA OSLO CHÊNE CAVIAR CIMENT MAR ONIX	
 <p>51.5</p> <p>48</p> <p>100</p> <p>Requiert plateau pag. 36</p>	U50201	Élém. bas tir.+cont. 100 Modulable	BLANC ALASKA OSLO CHÊNE CAVIAR	BLANC ALASKA OSLO CHÊNE CAVIAR CIMENT MAR ONIX	
 <p>51.5</p> <p>48</p> <p>125</p> <p>Requiert plateau pag. 36</p>	U50202	Élém. bas tir.+cont. 125 Modulable	BLANC ALASKA OSLO CHÊNE CAVIAR	BLANC ALASKA OSLO CHÊNE CAVIAR CIMENT MAR ONIX	
 <p>51.5</p> <p>48</p> <p>150</p> <p>Requiert plateau pag. 36</p>	U50203	Élém. bas tir.+cont. 150 Modulable	BLANC ALASKA OSLO CHÊNE CAVIAR	BLANC ALASKA OSLO CHÊNE CAVIAR CIMENT MAR ONIX	

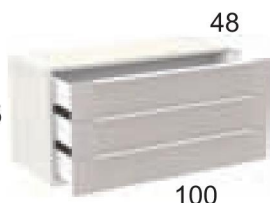

ÉLÉMENTS BAS 3 TIROIRS (Modulables)

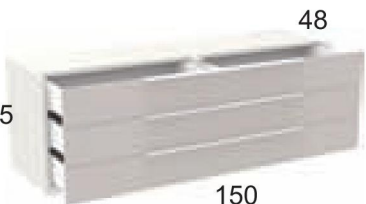
Coulisses occultes avec amortisseurs

DIMENSIONS	REF.	DESCRIPTION	COULEUR STRUCT.	COULEUR FAÇADE	POINTS
 <p>51.5</p> <p>48</p> <p>75</p> <p>Requiert plateau pag. 36</p>	U50220	Élément bas 3 tiroirs 75 Modulable	BLANC ALASKA OSLO CHÊNE CAVIAR	BLANC ALASKA OSLO CHÊNE CAVIAR CIMENT MAR ONIX	
 <p>51.5</p> <p>48</p> <p>100</p> <p>Requiert plateau pag. 36</p>	U50221	Élément bas 3 tiroirs 100 Modulable	BLANC ALASKA OSLO CHÊNE CAVIAR	BLANC ALASKA OSLO CHÊNE CAVIAR CIMENT MAR ONIX	
 <p>51.5</p> <p>48</p> <p>125</p> <p>Requiert plateau pag. 36</p>	U50222	Élément bas 3 tiroirs 125 Modulable	BLANC ALASKA OSLO CHÊNE CAVIAR	BLANC ALASKA OSLO CHÊNE CAVIAR CIMENT MAR ONIX	
 <p>51.5</p> <p>48</p> <p>150</p> <p>Requiert plateau pag. 36</p>	U50223	Élément bas 3 tiroirs 150 Modulable	BLANC ALASKA OSLO CHÊNE CAVIAR	BLANC ALASKA OSLO CHÊNE CAVIAR CIMENT MAR ONIX	

ÉLÉMENTS BAS VIDÉO / PORTE (Modulables)

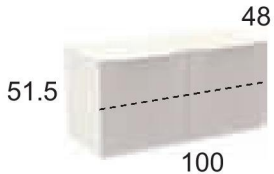
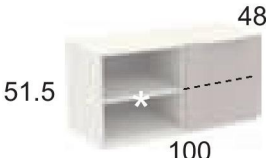
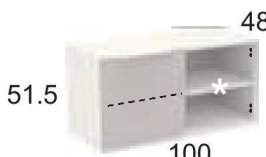
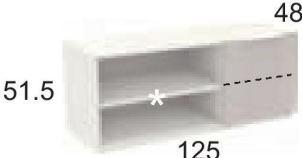
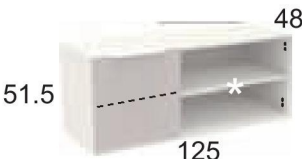
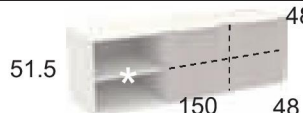
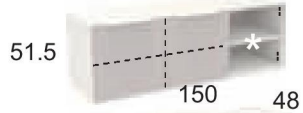
Portes montées sur la structure

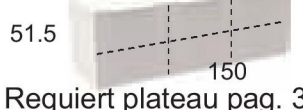
DIMENSIONS	REF.	DESCRIPTION	COULEUR STRUCT.	COULEUR FAÇADE	POINTS
 <p>51.5</p> <p>48</p> <p>100</p> <p>Requiert plateau pag. 36</p>	U50280	Éléments bas portes 100 Modulable	BLANC ALASKA OSLO CHÊNE CAVIAR	BLANC ALASKA OSLO CHÊNE CAVIAR CIMENT MAR ONIX	
 <p>51.5</p> <p>48</p> <p>100</p> <p>* Option illumination Pag. 60</p>  <p>51.5</p> <p>48</p> <p>100</p> <p>Requiert plateau pag. 36</p>	U50281 U50282	Élém. bas vidéo/porte 100 Droite Modulable Élém. bas vidéo/porte 100 Gauche Modulable	BLANC ALASKA OSLO CHÊNE CAVIAR	BLANC ALASKA OSLO CHÊNE CAVIAR CIMENT MAR ONIX	
 <p>51.5</p> <p>48</p> <p>125</p> <p>* Option illumination Pag. 60</p>  <p>51.5</p> <p>48</p> <p>125</p> <p>Requiert plateau pag. 36</p>	U50283 U50284	Élém. bas vidéo/porte 125 Droite Modulable Élém. bas vidéo/porte 125 Gauche Modulable	BLANC ALASKA OSLO CHÊNE CAVIAR	BLANC ALASKA OSLO CHÊNE CAVIAR CIMENT MAR ONIX	
 <p>51.5</p> <p>48</p> <p>150</p> <p>48</p>  <p>51.5</p> <p>48</p> <p>150</p> <p>48</p>  <p>51.5</p> <p>48</p> <p>150</p> <p>48</p>  <p>51.5</p> <p>150</p> <p>Requiert plateau pag. 36</p>	U50286 U50287 U50288 U50289	Élém. bas vidéo à Gauche Modulable Élém. bas vidéo à Droite Modulable Élém. bas vidéo au Centre Modulable Élém. bas vidéo 3 portes Modulable	BLANC ALASKA OSLO CHÊNE CAVIAR	BLANC ALASKA OSLO CHÊNE CAVIAR CIMENT MAR ONIX	

ÉLÉMENTS BAS PORTES 100 (Modulables)

Coulisses occultes avec amortisseurs

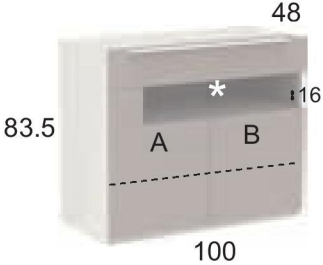
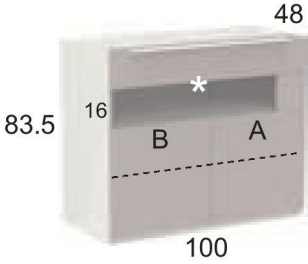
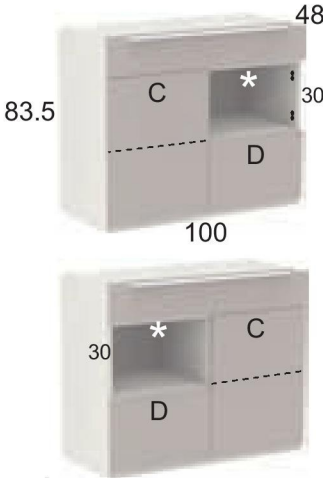
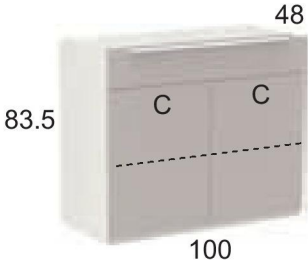
DIMENSIONS	REF.	DESCRIPTION	COULEUR STRUCT.	COULEUR FAÇADE	POINTS
 <p>83.5 48 16 100</p> <p>* Option illumination Pag. 60 Requiert plateau pag. 36</p>	U50506	Buffet portes verre Gauche Modulable			
 <p>83.5 48 16 100</p> <p>* Option illumination Pag. 60 Requiert plateau pag. 36</p>	U50507	Buffet portes verre Droite Modulable		BLANC ALASKA OSLO CHÊNE CAVIAR CIMENT MAR ONIX	
 <p>83.5 48 30 100</p> <p>* Option illumination Pag. 60 Requiert plateau pag. 36</p>	U50515	Buffet niche Gauche - Droite Modulable		BLANC ALASKA OSLO CHÊNE CAVIAR CIMENT MAR ONIX	
 <p>83.5 48 100</p> <p>Requiert plateau pag. 36</p>	U50516	Buffet Portes Modulable		BLANC ALASKA OSLO CHÊNE CAVIAR CIMENT MAR ONIX	

ÉLÉMENTS BAS PORTES 100 (Modulables)

Coulisses occultes avec amortisseurs

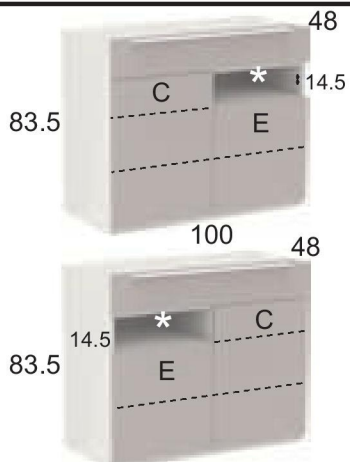
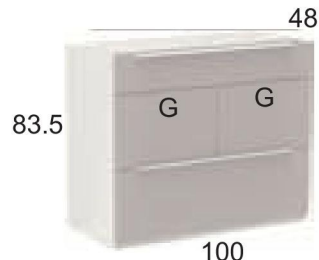
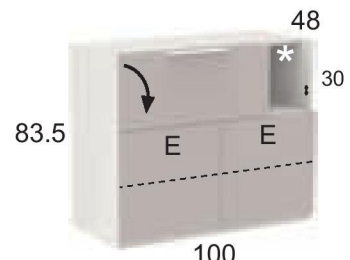
DIMENSIONS	REF.	DESCRIPTION	COULEUR STRUCT.	COULEUR FAÇADE	POINTS
 <p>* Option illumination Pag. 60 Requiert plateau pag. 36</p>	U50518	Buffet petite niche Gauche - Droite Modulable	BLANC ALASKA OSLO CHÊNE CAVIAR	BLANC ALASKA OSLO CHÊNE CAVIAR CIMENT MAR ONIX	
 <p>Requiert plateau pag. 36</p>	U50519	Buffet container Modulable	BLANC ALASKA OSLO CHÊNE CAVIAR	BLANC ALASKA OSLO CHÊNE CAVIAR CIMENT MAR ONIX	
 <p>* Option illumination Pag. 60 Requiert plateau pag. 36</p>	U50517	Buffet pte. abattante Modulable	BLANC ALASKA OSLO CHÊNE CAVIAR	BLANC ALASKA OSLO CHÊNE CAVIAR CIMENT MAR ONIX	

ÉLÉMENTS BAS PORTES 150 (Modulables)

Coulisses occultes avec amortisseurs

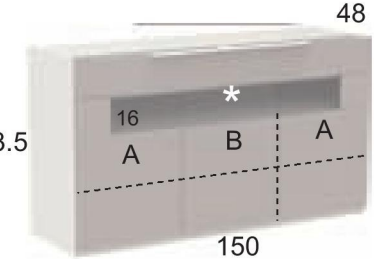
 <p>* Option illumination Pag. 60 Requiert plateau pag. 36</p>	U50508	Buffet portes verre Modulable	BLANC ALASKA OSLO CHÊNE CAVIAR	BLANC ALASKA OSLO CHÊNE CAVIAR CIMENT MAR ONIX	
---	---------------	---	--	---	--

ÉLÉM. BAS PORTES 150 (Modulables)

Coulisses occultes avec amortisseurs

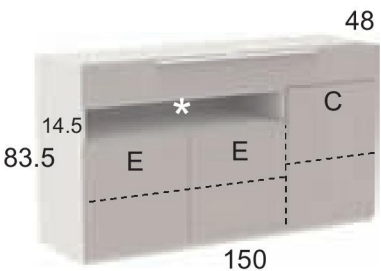
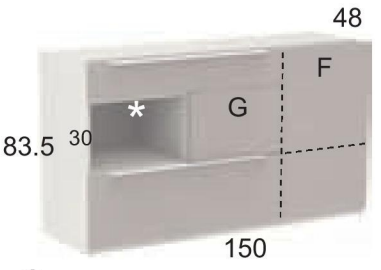
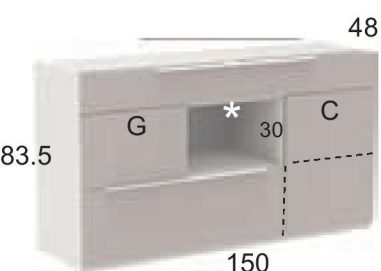
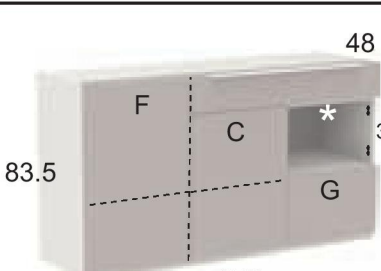
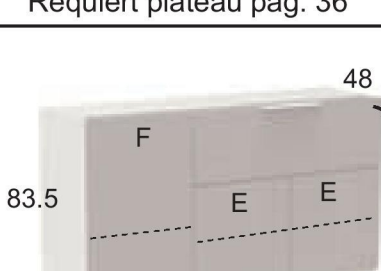
DIMENSIONS	REF.	DESCRIPTION	COULEUR STRUCT.	COULEUR FAÇADE	POINTS
 <p>48 14.5 83.5 E E C 150 * Option illumination Pag. 60 Requiert plateau pag. 36</p>	U50525	Buffet petite niche Modulable	BLANC ALASKA OSLO CHÊNE CAVIAR	BLANC ALASKA OSLO CHÊNE CAVIAR CIMENT MAR ONIX	
 <p>48 83.5 30 G F 150 * Option illumination Pag. 60 Requiert plateau pag. 36</p>	U50529	Buffet container Modulable	BLANC ALASKA OSLO CHÊNE CAVIAR	BLANC ALASKA OSLO CHÊNE CAVIAR CIMENT MAR ONIX	
 <p>48 83.5 G * 30 C 150 * Option illumination Pag. 60 Requiert plateau pag. 36</p>	U50527	Buffet container Modulable	BLANC ALASKA OSLO CHÊNE CAVIAR	BLANC ALASKA OSLO CHÊNE CAVIAR CIMENT MAR ONIX	
 <p>48 83.5 F C * 30 G 150 * Option illumination Pag. 60 Requiert plateau pag. 36</p>	U50528	Buffet niche Modulable	BLANC ALASKA OSLO CHÊNE CAVIAR	BLANC ALASKA OSLO CHÊNE CAVIAR CIMENT MAR ONIX	
 <p>48 83.5 F E E 150 Requiert plateau pag. 36</p>	U50526	Buffet pte. abattante Modulable	BLANC ALASKA OSLO CHÊNE CAVIAR	BLANC ALASKA OSLO CHÊNE CAVIAR CIMENT MAR ONIX	

PLATEAUX POUR ÉLÉMENTS BAS

EXEMPLES (Modulables)

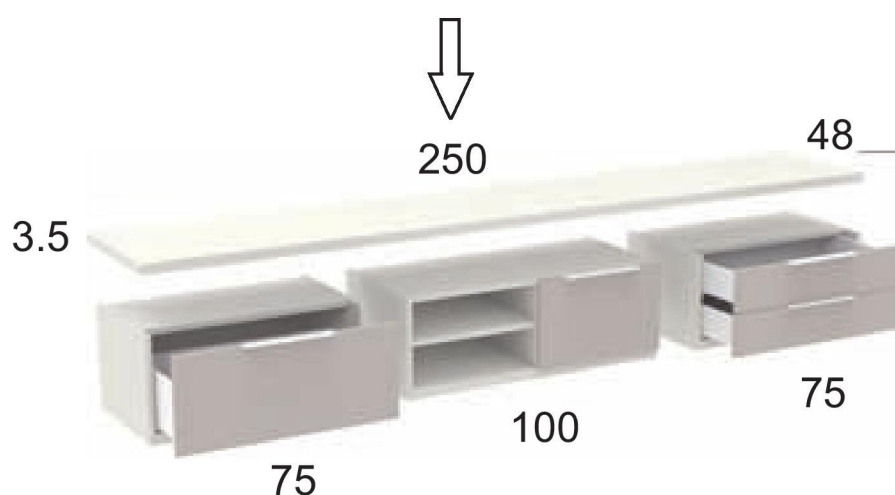
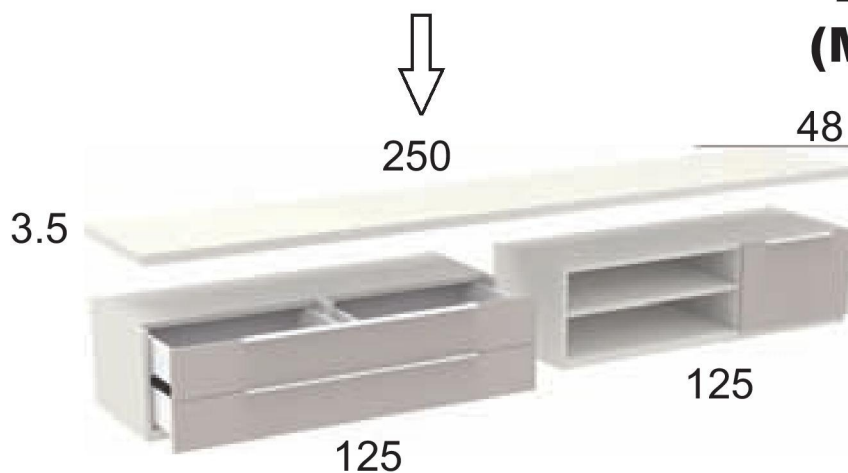

DIMENSIONS	REF.	DESCRIPTION	COULEUR	POINTS
<p>75 - 100 - 125 150 - 175 - 200 225 - 250 - 275</p>	U50800	Plateau de 75	BLANC ALASKA OSLO CHÊNE CAVIAR	
	U50801	Plateau de 100		
	U50802	Plateau de 125		
	U50803	Plateau de 150		
	U50804	Plateau de 175		
	U50805	Plateau de 200		
	U50806	Plateau de 225		
	U50807	Plateau de 250		
	U50808	Plateau de 275		

VITRINES



Page: 38



Page: 39

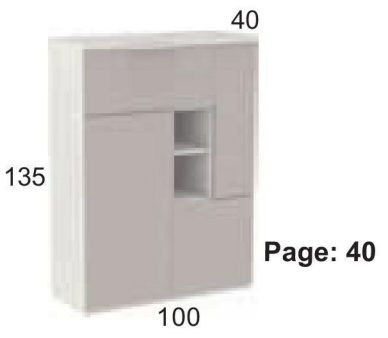

Page: 40

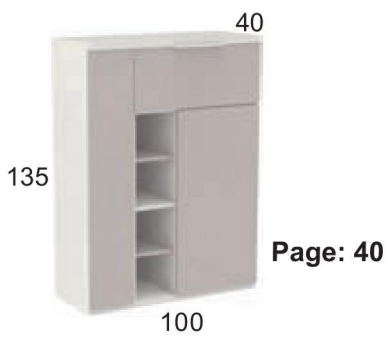

Page: 40

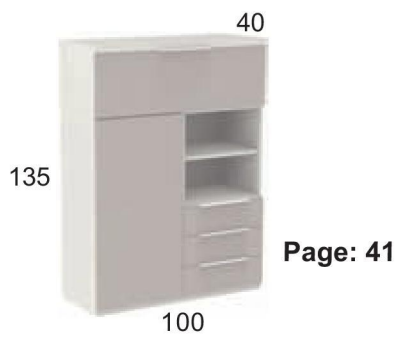

Page: 41

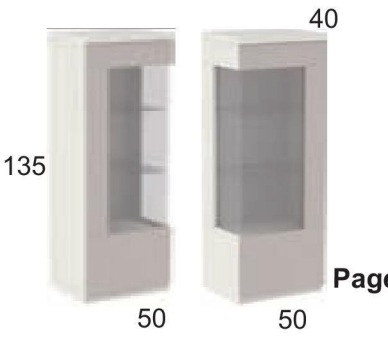

Page: 42

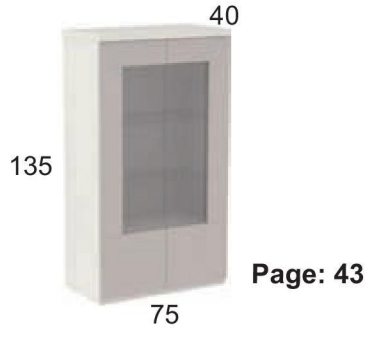

Page: 43

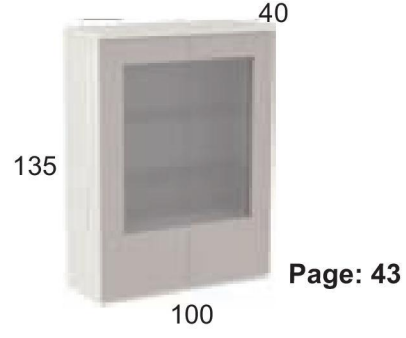

Page: 43

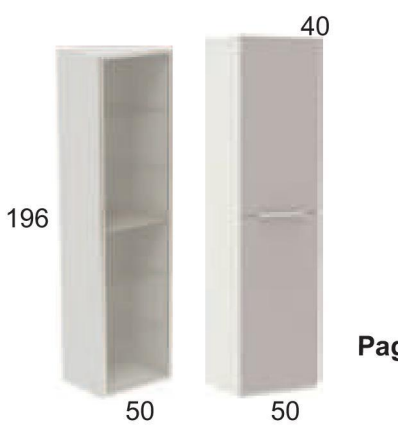

Page: 44



Page: 45

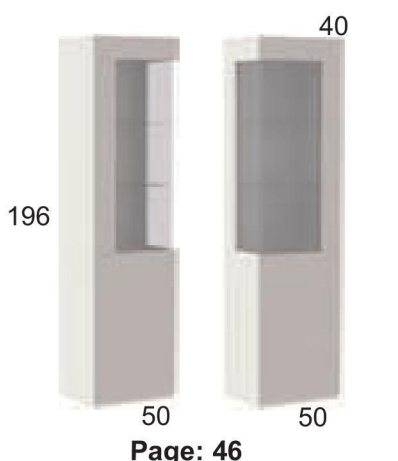

Page: 46



Page: 47



Page: 47



Page: 47

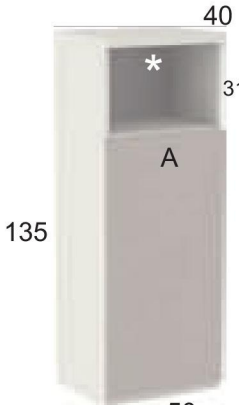
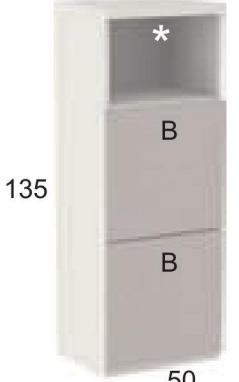
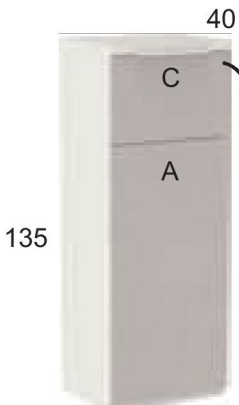
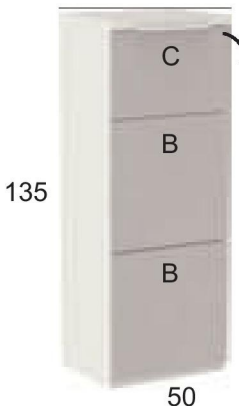

VITRINES
ÉTAGÈRES

VITRINES (135*50)

DIMENSIONS	REF.	DESCRIPTION	COULEUR	COULEUR FAÇADE	POINTS
 <p>135</p> <p>40</p> <p>31</p> <p>A</p> <p>50</p> <p>* Option illumination Pag. 60</p>	U50400	Vitrine en 50 gch-dte (1 porte panneau)			
	U50401	Vitrine en 50 gch-dte (1 porte verre) "A" FUMÉ - BLANC - MAR - ONIX		BLANC ALASKA OSLO CHÊNE CAVIAR CIMENT MAR ONIX	
	 <p>135</p> <p>40</p> <p>B</p> <p>B</p> <p>50</p>	U50402	Vitrine en 50 gch-dte (2 portes panneau)		
 <p>135</p> <p>40</p> <p>C</p> <p>A</p> <p>50</p>	U50404	Vitrine pte abatt. 50 gch-dte (2 portes panneau)			
	U50405	Vitrine pte abatt. 50 gch-dte (1+1 Porte verre) "A" FUMÉ BLANC MAR ONIX		BLANC ALASKA OSLO CHÊNE CAVIAR CIMENT MAR ONIX	
	 <p>135</p> <p>40</p> <p>C</p> <p>B</p> <p>B</p> <p>50</p>	U50406	Vitrine pte abatt. 50 gch-dte (3 portes panneau)		

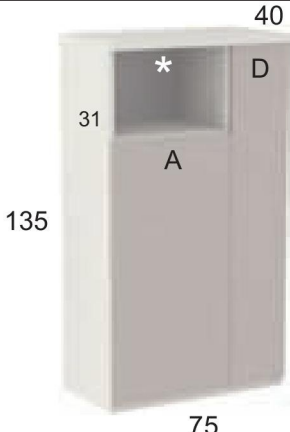
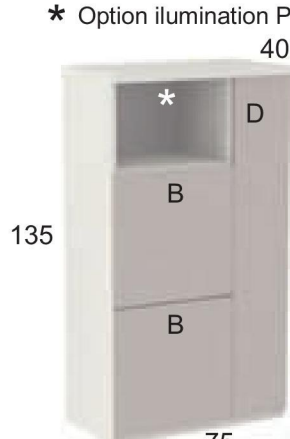
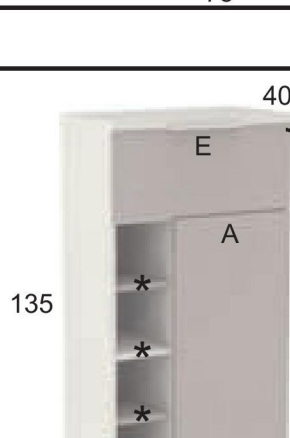
VITRINES (135*75)

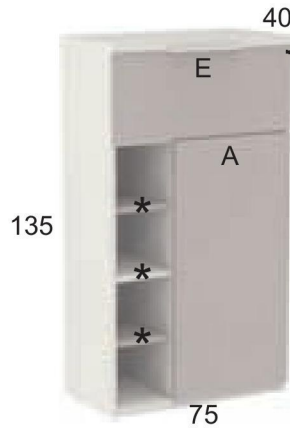
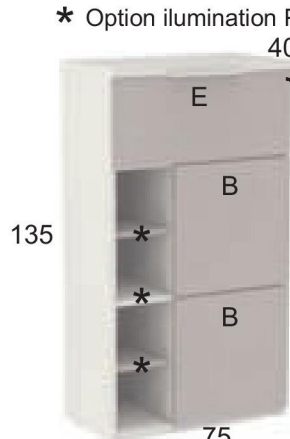
DIMENSIONS	REF.	DESCRIPTION	COULEUR	COULEUR FAÇADE	POINTS
 <p>40 31 135 75 A D *</p>	U50410	Vitrine en 75 (2 portes panneau)			
 <p>40 31 135 75 A D *</p> <p>* Option illumination Pag. 60</p>	U50411	Vitrine en 75 (1+1 Porte verre) "A" FUMÉ BLANC MAR ONIX			
 <p>40 31 135 75 B D *</p>	U50412	Vitrine en 75 (3 portes panneau)	BLANC ALASKA OSLO CHÊNE CAVIAR	BLANC ALASKA OSLO CHÊNE CAVIAR CIMENT MAR ONIX	

 <p>40 31 135 75 A E *</p>	U50414	Vitrine pte abatt. 75 (2 portes panneau)			
 <p>40 31 135 75 A E *</p> <p>* Option illumination Pag. 60</p>	U50415	Vitrine pte abatt. 75 (1+1 Porte verre) "A" FUMÉ BLANC MAR ONIX			
 <p>40 31 135 75 B E *</p>	U50416	Vitrine pte abatt. 75 (3 portes panneau)	BLANC ALASKA OSLO CHÊNE CAVIAR	BLANC ALASKA OSLO CHÊNE CAVIAR CIMENT MAR ONIX	

VITRINES PORTES (135 x 100)

DIMENSIONS	REF.	DESCRIPTION	COULEUR	COULEUR FAÇADE	POINTS
<p>135</p> <p>40</p> <p>E F</p> <p>A B</p> <p>100</p> <p>* Option illumination Pag. 60</p>	U50428	Vitrine portes 100 (4 Portes panneau)			
	U50429	Vitrine portes 100 (3+1 Portes verre) "A" FUMÉ - BLANC - MAR - ONIX		BLANC ALASKA OSLO CHÊNE CAVIAR	BLANC ALASKA OSLO CHÊNE CAVIAR CIMENT MAR ONIX
<p>135</p> <p>40</p> <p>E F</p> <p>B B</p> <p>B B</p> <p>100</p> <p>* Option illumination Pag. 60</p>	U50430	Vitrine portes 100 (5 Portes panneau)			
<p>135</p> <p>40</p> <p>D E</p> <p>A</p> <p>100</p> <p>* Option illumination Pag. 60</p>	U50420	Vitrine étagère 100 (3 Portes panneau)			
	U50421	Vitrine étagère 100 (2+1 Portes verre) "A" FUMÉ - BLANC - MAR - ONIX		BLANC ALASKA OSLO CHÊNE CAVIAR	BLANC ALASKA OSLO CHÊNE CAVIAR CIMENT MAR ONIX
<p>135</p> <p>40</p> <p>D E</p> <p>B B</p> <p>B B</p> <p>100</p> <p>* Option illumination Pag. 60</p>	U50422	Vitrine étagère 100 (4 Portes panneau)			

VITRINES TIROIRS (135 x 100)

Coulisses occultes avec amortisseurs

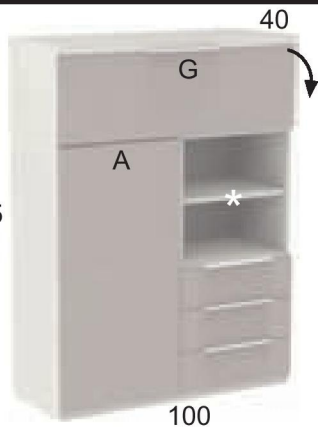
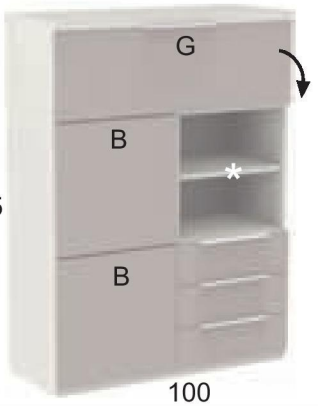
DIMENSIONS	REF.	DESCRIPTION	COULEUR	COULEUR FAÇADE	POINTS
 <p>135</p> <p>40</p> <p>G</p> <p>A</p> <p>100</p> <p>* Option illumination Pag. 60</p>	U50424	Vitrine Tiroirs 100 (2 portes panneau)			
	U50425	Vitrine Tiroirs 100 (1+1 Porte verre) "A" FUMÉ - BLANC - MAR - ONIX		BLANC ALASKA OSLO CHÈNE CAVIAR	BLANC ALASKA OSLO CHÈNE CAVIAR CIMENT MAR ONIX
	 <p>135</p> <p>40</p> <p>G</p> <p>B</p> <p>B</p> <p>100</p> <p>* Option illumination Pag. 60</p>	U50426	Vitrine Tiroirs 100 (3 portes panneau)		

Note : Découpes SPÉCIALES page 3

Définir la couleur de la poignée (par défaut couleur alu)

VITRINES VERRE

Portes montées sur la structure

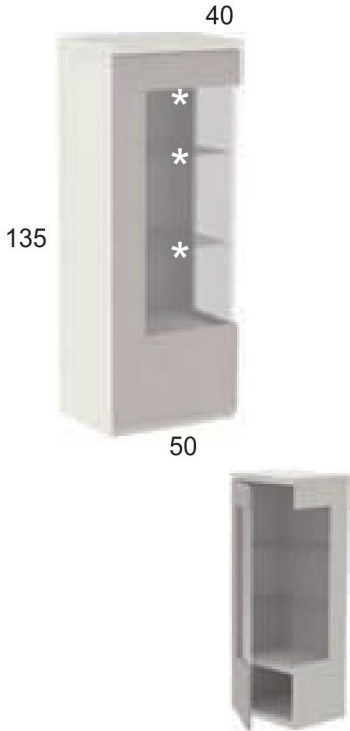
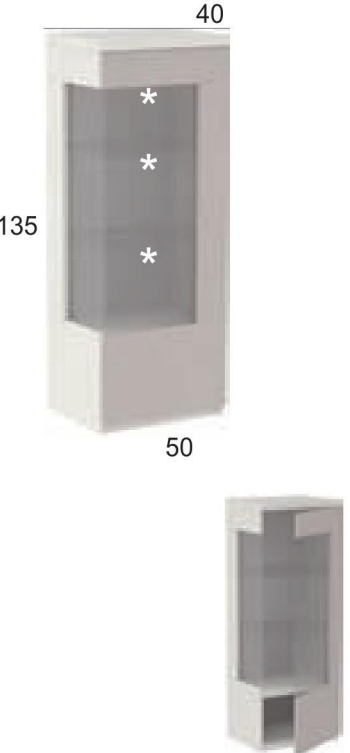
DIMENSIONS	REF.	DESCRIPTION	COULEUR	COULEUR FAÇADE	POINTS
 <p>135</p> <p>40</p> <p>50</p> <p>* Option illumination Pag. 60</p>	U50432	<p>Vitrine verre 135x50 Gauche</p> <p>Verre fumé</p>	<p>BLANC ALASKA OSLO CHÊNE CAVIAR</p>	<p>BLANC ALASKA OSLO CHÊNE CAVIAR CIMENT MAR ONIX</p>	
 <p>135</p> <p>40</p> <p>50</p> <p>* Option illumination Pag. 60</p>	U50433	<p>Vitrine verre 135x50 Droite</p> <p>Verre fumé</p>	<p>BLANC ALASKA OSLO CHÊNE CAVIAR</p>	<p>BLANC ALASKA OSLO CHÊNE CAVIAR CIMENT MAR ONIX</p>	

VITRINES VERRE

Portes montées sur la structure

DIMENSIONS	REF.	DESCRIPTION	COULEUR	COULEUR FAÇADE	POINTS
 <p>135</p> <p>40</p> <p>75</p> <p>* Option illumination Pag. 60</p>	U50434	<p>Vitrine verre 135x75</p> <p>Verre fumé</p>	<p>BLANC ALASKA OSLO CHÊNE CAVIAR</p>	<p>BLANC ALASKA OSLO CHÊNE CAVIAR CIMENT MAR ONIX</p>	

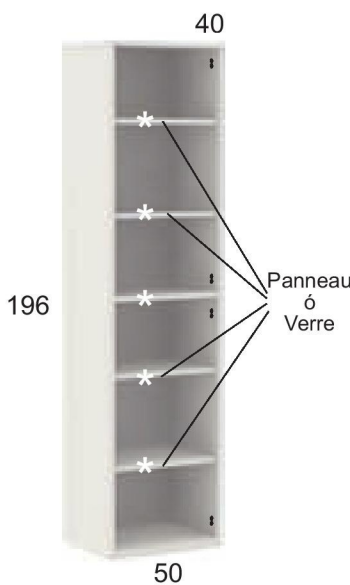

 <p>135</p> <p>40</p> <p>100</p> <p>* Option illumination Pag. 60</p>	U50435	<p>Vitrine verre 135x100</p> <p>Verre fumé</p>	<p>BLANC ALASKA OSLO CHÊNE CAVIAR</p>	<p>BLANC ALASKA OSLO CHÊNE CAVIAR CIMENT MAR ONIX</p>	
--	---------------	--	---	---	--

VITRINES (hauteur 196)

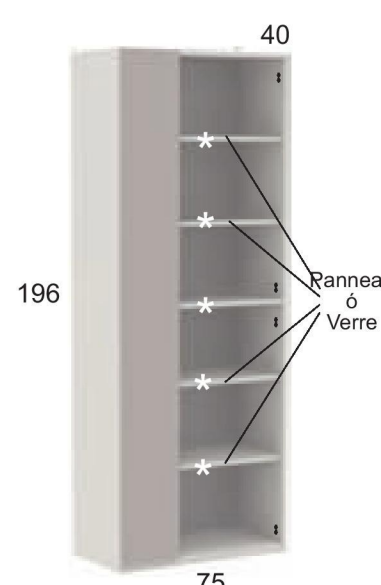
DIMENSIONS	REF.	DESCRIPTION	COULEUR	POINTS
 <p>196</p> <p>40</p> <p>50</p> <p>Panneau ou Verre</p> <p>* Option illumination Pag. 60</p> <p>Nécessaire 2 portes de 96 ou Nécessaire 1 porte de 192</p> <p>→ voir page suivante</p>	U50450	Vitrine en 50 1 étagère fixe panneau 4 étagères amovibles PANNEAU	BLANC ALASKA OSLO CHÊNE CAVIAR	
	U50451	Vitrine en 50 1 étagère fixe panneau 4 étagères amovibles VERRE		

 <p>196</p> <p>40</p> <p>75</p> <p>Panneau ou Verre</p> <p>* Option illumination Pag. 60</p> <p>Nécessaire 2 portes de 96 ou Nécessaire 1 porte de 192</p> <p>→ voir page suivante</p>	U50454	Vitrine en 75 1 étagère fixe panneau 4 étagères amovibles PANNEAU	BLANC ALASKA OSLO CHÊNE CAVIAR	
	U50455	Vitrine en 75 1 étagère fixe panneau 4 étagères amovibles VERRE		BLANC ALASKA OSLO CHÊNE CAVIAR

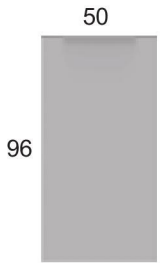
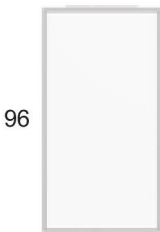
PORTES POUR VITRINE (hauteur 196)

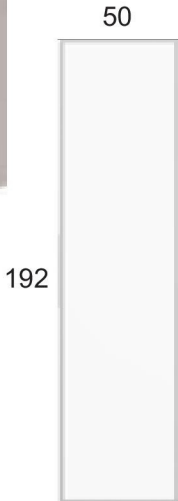
DIMENSIONS	REF.	DESCRIPTION	COULEUR	POINTS
 	U50384	Porte de 96 (Panneau)	BLANC ALASKA OSLO CHÊNE CAVIAR CIMENT MAR ONIX	
		Porte de 96 (Verre) Contour aluminium	FUMÉ BLANC MAR ONIX	
 	U50388	Porte de 192 (Panneau)	BLANC ALASKA OSLO CHÊNE CAVIAR CIMENT MAR ONIX	
		Porte 192 (Verre) Contour aluminium	FUMÉ BLANC MAR ONIX	

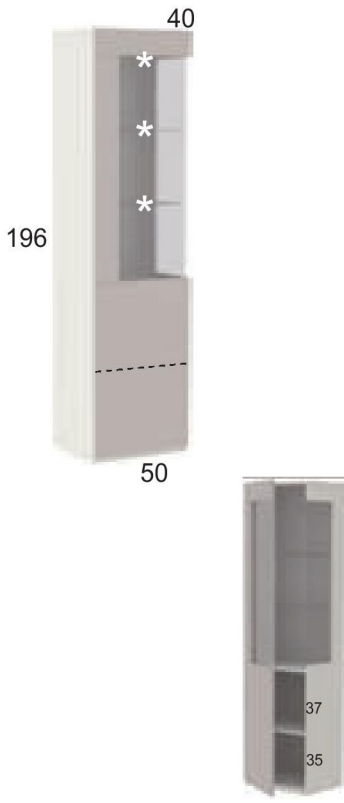

VITRINES (hauteur 196)

Portes montées sur la structure

DIMENSIONS	REF.	DESCRIPTION	COULEUR	COULEUR FAÇADE	POINTS
 <p>196</p> <p>40</p> <p>50</p> <p>37</p> <p>35</p> <p>* Option illumination Pag. 60</p>	U50471	<p>Vitrine Verre 196*50 Droite</p> <p>Verre fumé</p>	<p>BLANC ALASKA OSLO CHÊNE CAVIAR</p>	<p>BLANC ALASKA OSLO CHÊNE CAVIAR CIMENT MAR ONIX</p>	
 <p>196</p> <p>40</p> <p>50</p> <p>37</p> <p>35</p> <p>* Option illumination Pag. 60</p>	U50470	<p>Vitrine Verre 196*50 Gauche</p> <p>Verre fumé</p>	<p>BLANC ALASKA OSLO CHÊNE CAVIAR</p>	<p>BLANC ALASKA OSLO CHÊNE CAVIAR CIMENT MAR ONIX</p>	

VITRINES ET ÉTAGÈRE (hauteur 196)

Portes montées sur la structure

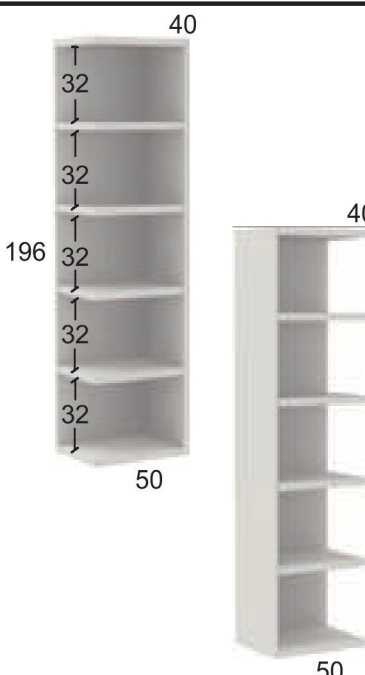
DIMENSIONS	REF.	DESCRIPTION	COULEUR	COULEUR FAÇADE	POINTS
 <p>40</p> <p>196</p> <p>75</p> <p>* Option illumination Pag. 60</p>	U50472	<p>Vitrine Verre 196*75</p> <p>Verre fumé</p>	<p>BLANC ALASKA OSLO CHÊNE CAVIAR</p>	<p>BLANC ALASKA OSLO CHÊNE CAVIAR CIMENT MAR ONIX</p>	
 <p>40</p> <p>196</p> <p>100</p> <p>* Option illumination Pag. 60</p>	U50473	<p>Vitrine Verre 196*100</p> <p>Verre fumé</p>	<p>BLANC ALASKA OSLO CHÊNE CAVIAR</p>	<p>BLANC ALASKA OSLO CHÊNE CAVIAR CIMENT MAR ONIX</p>	
 <p>40</p> <p>196</p> <p>32</p> <p>32</p> <p>32</p> <p>32</p> <p>32</p> <p>32</p> <p>50</p> <p>40</p> <p>50</p>	U50475	<p>Étagère ouverte de 196</p> <p>GAUCHE - DROITE</p> <p>Livrée démontée</p>		<p>BLANC ALASKA OSLO CHÊNE CAVIAR</p>	

ÉLÉMENTS HAUTS POUR SUSPENDRE

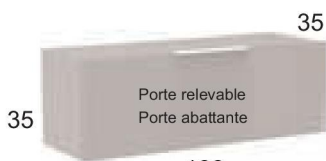

Page: 50-51



Page: 50-51

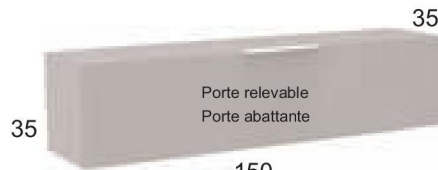

Page: 50-51

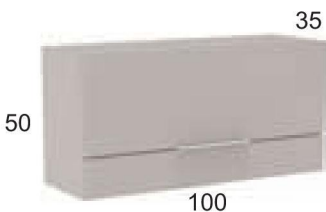

Page: 52-53



Page: 52-53

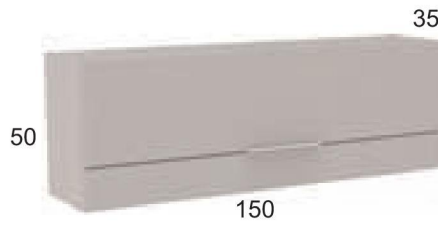

Page: 52-53

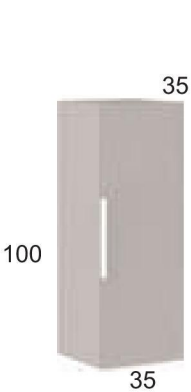

Page: 54-55

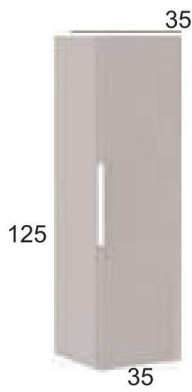

Page: 54-55

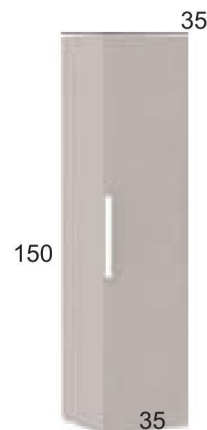

Page: 54-55

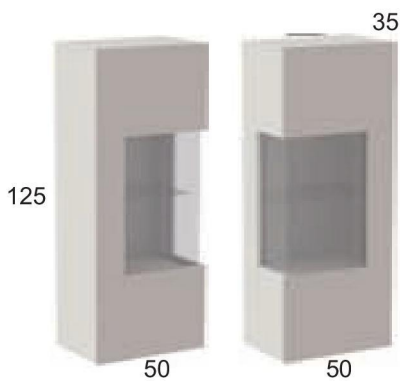

Page: 56

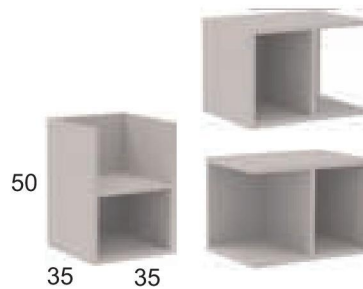

Page: 56

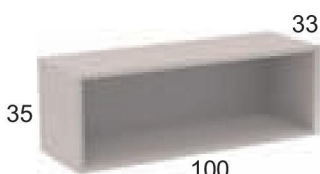

Page: 57



Page: 57

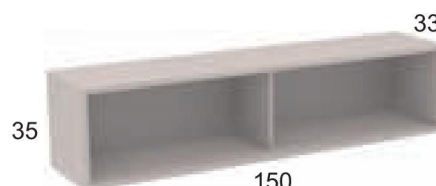

Page: 57

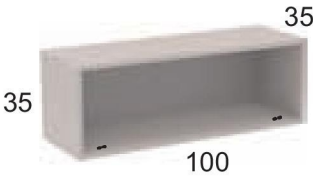
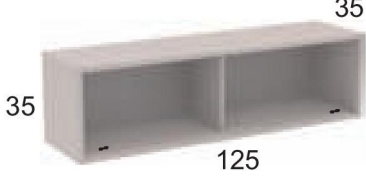
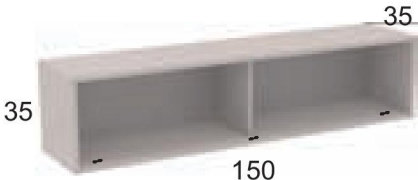

ÉLÉMENTS HAUTS POUR SUSPENDRE (haut. 35)

DIMENSIONS	REF.	DESCRIPTION	COULEUR	POINTS
 <p>35 100</p> <p>Nécessaire 1 porte 100 → voir page suivante</p>	U50700	Structure élém. haut 1 porte 100 (Relevable)	BLANC ALASKA OSLO CHÊNE CAVIAR CIMENT MAR ONIX	
	U50701	Structure élém. haut 1 porte 100 (Abattante)		
 <p>35 125</p> <p>Nécessaire 1 porte 125 → voir page suivante</p>	U50702	Structure élém. haut 1 porte 125 (Relevable)	BLANC ALASKA OSLO CHÊNE CAVIAR CIMENT MAR ONIX	
	U50703	Structure élém. haut 1 porte 125 (Abattante)		
 <p>35 150</p> <p>Nécessaire 1 porte 150 → voir page suivante</p>	U50704	Structure élém. haut 1 porte 150 (Relevable)	BLANC ALASKA OSLO CHÊNE CAVIAR CIMENT MAR ONIX	
	U50705	Structure élém. haut 1 porte 150 (Abattante)		

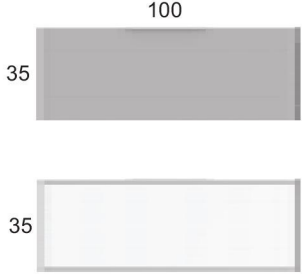
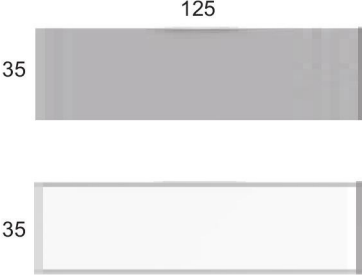
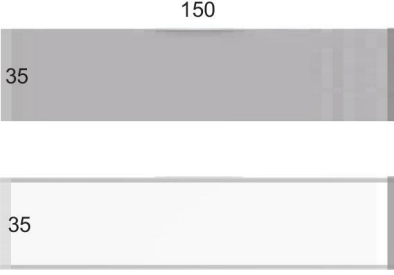
PORTES POUR ÉLÉMENTS HAUTS (haut. 35)

DIMENSIONS	REF.	DESCRIPTION	COULEUR	POINTS
 <p>100 35</p>	U50707	Porte de 100 (Panneau)	BLANC ALASKA OSLO CHÊNE CAVIAR CIMENT MAR ONIX	
		Porte de 100 (Verre) Contour aluminium	FUMÉ BLANC MAR ONIX	
 <p>125 35</p>	U50708	Porte de 125 (Panneau)	BLANC ALASKA OSLO CHÊNE CAVIAR CIMENT MAR ONIX	
		Porte de 125 (Verre) Contour aluminium	FUMÉ BLANC MAR ONIX	
 <p>150 35</p>	U50709	Porte de 150 (Panneau)	BLANC ALASKA OSLO CHÊNE CAVIAR CIMENT MAR ONIX	
		Porte de 150 (Verre) Contour aluminium	FUMÉ BLANC MAR ONIX	

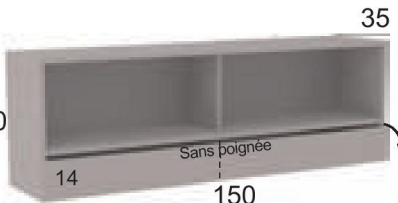

ÉLÉMENTS HAUTS POUR SUSPENDRE (haut. 50)

DIMENSIONS	REF.	DESCRIPTION	COULEUR STRUCT.	COULEUR P. ÉTROITE	POINTS
 <p>Nécessaire 1 porte 100 → voir page suivante</p>	U50710	Structure élém. haut porte étroite de 100	BLANC ALASKA CHÊNE CAVIAR CIMENT MAR ONIX	BLANC ALASKA CHÊNE CAVIAR CIMENT MAR ONIX	
 <p>Nécessaire 1 porte 125 → voir page suivante</p>	U50711	Structure élém. haut porte étroite de 125	BLANC ALASKA CHÊNE CAVIAR CIMENT MAR ONIX	BLANC ALASKA CHÊNE CAVIAR CIMENT MAR ONIX	
 <p>Nécessaire 1 porte 150 → voir page suivante</p>	U50712	Structure élém. haut porte étroite de 150	BLANC ALASKA CHÊNE CAVIAR CIMENT MAR ONIX	BLANC ALASKA CHÊNE CAVIAR CIMENT MAR ONIX	

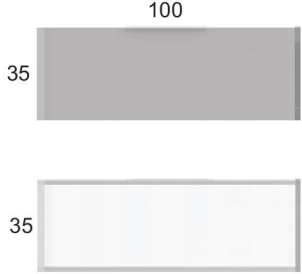
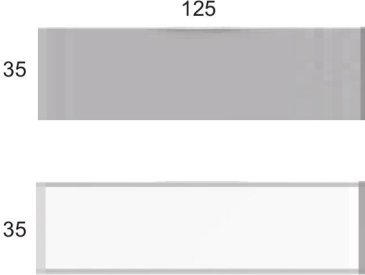
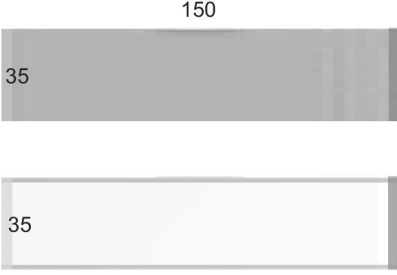
PORTES POUR ÉLÉMENTS HAUTS (haut. 50)

DIMENSIONS	REF.	DESCRIPTION	COULEUR	POINTS
 <p>100 35</p>	U50707	Porte de 100 (Panneau)	BLANC ALASKA OSLO CHÈNE CAVIAR CIMENT MAR ONIX	
		Porte de 100 (Verre) Contour aluminium	FUMÉ BLANC MAR ONIX	
 <p>125 35</p>	U50708	Porte de 125 (Panneau)	BLANC ALASKA OSLO CHÈNE CAVIAR CIMENT MAR ONIX	
		Porte de 125 (Verre) Contour aluminium	FUMÉ BLANC MAR ONIX	
 <p>150 35</p>	U50709	Porte de 150 (Panneau)	BLANC ALASKA OSLO CHÈNE CAVIAR CIMENT MAR ONIX	
		Porte de 150 (Verre) Contour aluminium	FUMÉ BLANC MAR ONIX	

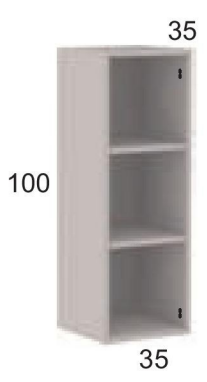
ÉLÉMENTS HAUTS VERT. POUR SUSPENDRE

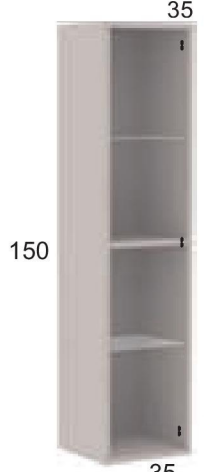
DIMENSIONS	REF.	DESCRIPTION	COULEUR	POINTS
 <p>100</p> <p>35</p> <p>35</p> <p>Nécessaire 1 porte 100 → voir page suivante</p>	U50730	Structure élém. haut vertical 100	BLANC ALASKA OSLO CHÊNE CAVIAR CIMENT MAR ONIX	
 <p>125</p> <p>35</p> <p>35</p> <p>Nécessaire 1 porte 125 → voir page suivante</p>	U50731	Structure élém. haut vertical 125	BLANC ALASKA OSLO CHÊNE CAVIAR CIMENT MAR ONIX	
 <p>150</p> <p>35</p> <p>35</p> <p>Nécessaire 1 porte 150 → voir page suivante</p>	U50732	Structure élém. haut vertical 150	BLANC ALASKA OSLO CHÊNE CAVIAR CIMENT MAR ONIX	

PORTES POUR ÉLÉMENTS HAUTS

DIMENSIONS	REF.	DESCRIPTION	COULEUR	POINTS
	U50707	Porte de 100 (Panneau)	BLANC ALASKA OSLO CHÊNE CAVIAR CIMENT MAR ONIX	
		Porte de 100 (Verre) Contour aluminium	FUMÉ BLANC MAR ONIX	
	U50708	Porte de 125 (Panneau)	BLANC ALASKA OSLO CHÊNE CAVIAR CIMENT MAR ONIX	
		Porte de 125 (Verre) Contour aluminium	FUMÉ BLANC MAR ONIX	
	U50709	Porte de 150 (Panneau)	BLANC ALASKA OSLO CHÊNE CAVIAR CIMENT MAR ONIX	
		Porte de 150 (Verre) Contour aluminium	FUMÉ BLANC MAR ONIX	

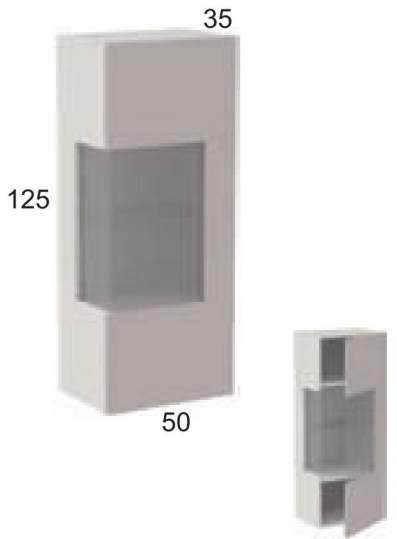
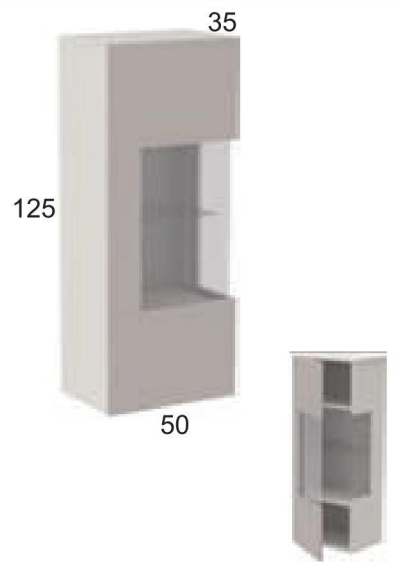

VITRINE HAUTE VERRE POUR SUSPENDRE

Portes montées sur la structure

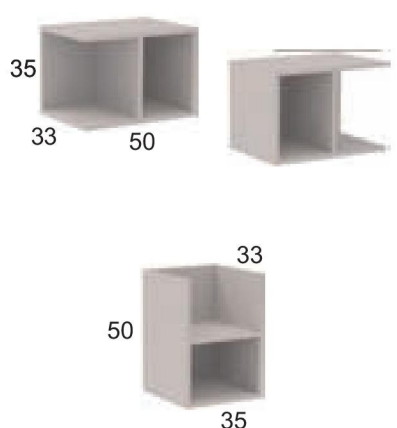

DIMENSIONS	REF.	DESCRIPTION	COULEUR STRUCT.	COULEUR FAÇADE	POINTS
 <p>125 50 35</p>	U50740	Vitrine haute Ouverture à Droite	BLANC ALASKA OSLO CHÊNE CAVIAR	BLANC ALASKA OSLO CHÊNE CAVIAR CIMENT MAR ONIX	
 <p>125 50 35</p>	U50741	Vitrine haute Ouverture à Gauche	BLANC ALASKA OSLO CHÊNE CAVIAR	BLANC ALASKA OSLO CHÊNE CAVIAR CIMENT MAR ONIX	

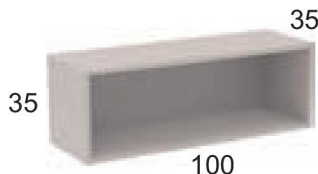
 <p>35 33 50 33 50 35</p>	U50757	Module étagère haute (horizontal - vertical)		BLANC ALASKA OSLO CHÊNE CAVIAR CIMENT MAR ONIX	
--	---------------	---	--	---	--

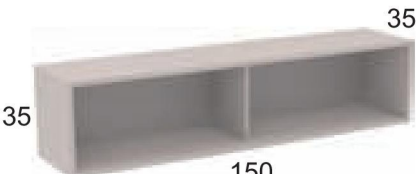
ÉTAGÈRES POUR SUSPENDRE

DIMENSIONS	REF.	DESCRIPTION	COULEUR	POINTS
 <p>35 100 35</p>	U50750	Module étagère haute 100	BLANC ALASKA OSLO CHÊNE CAVIAR CIMENT MAR ONIX	
 <p>35 125 35</p>	U50751	Module étagère haute 125	BLANC ALASKA OSLO CHÊNE CAVIAR CIMENT MAR ONIX	
 <p>35 150 35</p>	U50752	Module étagère haute 150	BLANC ALASKA OSLO CHÊNE CAVIAR CIMENT MAR ONIX	

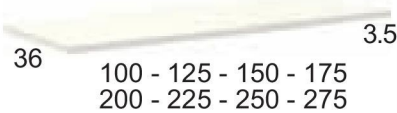
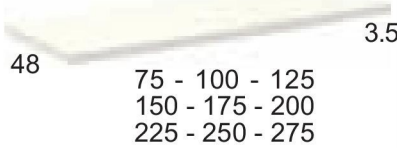
PLATEAUX ET PANNEAUX SUR MESURE

DIMENSIONS	REF.	DESCRIPTION	COULEUR	POINTS
 <p>36 100 - 125 - 150 - 175 200 - 225 - 250 - 275 3.5</p>	U50791	Plateau de 100	BLANC ALASKA OSLO CHÊNE CAVIAR	
	U50792	Plateau de 125		
	U50793	Plateau de 150		
	U50794	Plateau de 175		
	U50795	Plateau de 200		
	U50796	Plateau de 225		
	U50797	Plateau de 250		
	U50798	Plateau de 275		
 <p>48 75 - 100 - 125 150 - 175 - 200 225 - 250 - 275 3.5</p>	U50800	Plateau de 75	BLANC ALASKA OSLO CHÊNE CAVIAR	
	U50801	Plateau de 100		
	U50802	Plateau de 125		
	U50803	Plateau de 150		
	U50804	Plateau de 175		
	U50805	Plateau de 200		
	U50806	Plateau de 225		
	U50807	Plateau de 250		
U50808	Plateau de 275			
 <p>g Y X</p>	Panneau sur mesure : ep.19 mm chants non plaqués Panneau sur mesure : ep.19 mm chants plaqués		BLANC ALASKA OSLO CHÊNE CAVIAR CIMENT MAR ONIX MARMOL	
	Panneau sur mesure : ep.35 mm chants non plaqués Panneau sur mesure : ep.35 mm chants plaqués			
PRIX /m2		CDE MINIMUM		

PLATEAUX ET PIEDS

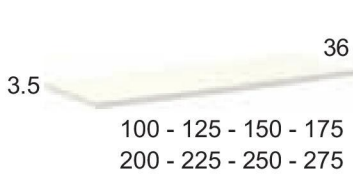

Page: 58

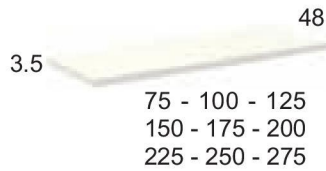

Page: 58



Page: 60



Page: 60

ILUMINATION ET ÉTAGÈRES

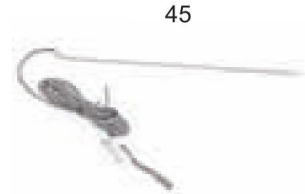
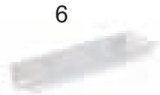

Page: 60

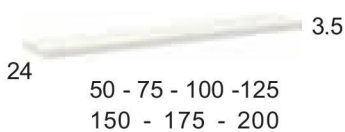

Page: 61

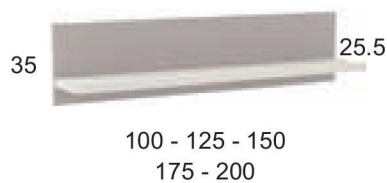

Page: 62

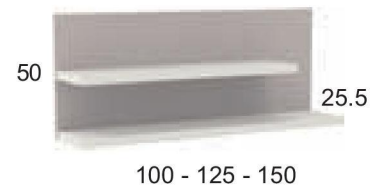

Page: 63



Page: 64

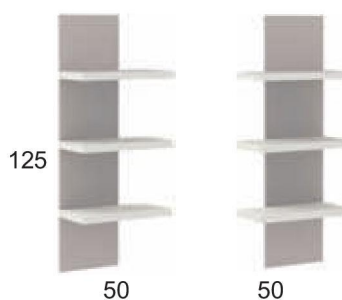

Page: 64

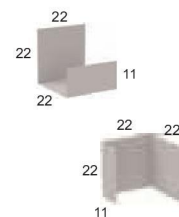





Page: 64

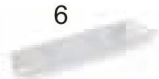

PLATEAUX ET PIEDS
ILUMINATION
ÉTAGÈRES

ILUMINATION







Fournie non installée

DIMENSIONS	REF.	DESCRIPTION	POINTS
 <p>21</p>	36352176	LAMPE LED (Pour étagère panneau, espace largeur 21cm)	
 <p>45</p>	36352177	LAMPE LED (Pour étagère panneau, espace largeur 45cm) (Requiert transformateur + poussoir pied)	
 <p>6</p>	36352178	LAMPE PINCE (Pour étagère verre) (Requiert transformateur + poussoir pied)	
	36352179	TRANSFORMATEUR + POUSSOIR PIED (Nécessaire 1 chaque 6 lampes) De 1 à 6 lampes → 1 jeu De 7 à 12 lampes → 2 jeux	



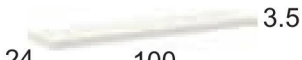

PIEDS (optionnels)

 <p>8</p>	18175	Jeu 4 pieds courbés	ALUMINIUM	
	18177	Jeu 6 pieds courbés		
 <p>12</p>	18183	Jeu 4 pieds hauts (ABS)	ALUMINIUM BLANC CIMENT MAR ONIX MARMOL	
	18184	Jeu 6 pieds hauts (ABS)		
 <p>9</p>	18060	Jeu 4 roues	NOIR	

ÉTAGÈRES MURALE

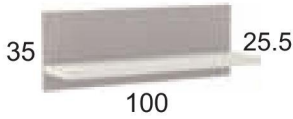
DIMENSIONS	REF.	DESCRIPTION	COULEUR	POINTS
	U50770	Étagère murale de 50 (2 Supports occultes)	BLANC ALASKA OSLO CHÊNE CAVIAR	
	U50771	Étagère murale de 75 (2 Supports occultes)	BLANC ALASKA OSLO CHÊNE CAVIAR	
	U50772	Étagère murale de 100 (2 Supports occultes)	BLANC ALASKA OSLO CHÊNE CAVIAR	
	U50773	Étagère murale de 125 (3 Supports occultes)	BLANC ALASKA OSLO CHÊNE CAVIAR	
	U50774	Étagère murale de 150 (3 Supports occultes)	BLANC ALASKA OSLO CHÊNE CAVIAR	
	U50775	Étagère murale de 175 (3 Supports occultes)	BLANC ALASKA OSLO CHÊNE CAVIAR	
	U50776	Étagère murale de 200 (4 Supports occultes)	BLANC ALASKA OSLO CHÊNE CAVIAR	

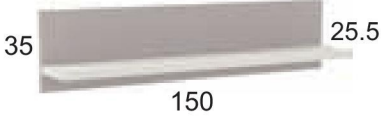
FOND PANNEAU + ÉTAGÈRE

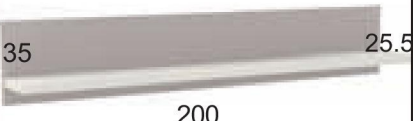
DIMENSIONS	REF.	DESCRIPTION	ÉTAGÈRE	FOND	POINTS
 <p>35 25.5 100</p>	U50780	Fond panneau + étagère	BLANC ALASKA OSLO CHÊNE CAVIAR	BLANC ALASKA OSLO CHÊNE CAVIAR CIMENT MAR ONIX MARMOL	
 <p>35 25.5 125</p>	U50781	Fond panneau + étagère	BLANC ALASKA OSLO CHÊNE CAVIAR	BLANC ALASKA OSLO CHÊNE CAVIAR CIMENT MAR ONIX MARMOL	
 <p>35 25.5 150</p>	U50782	Fond panneau + étagère	BLANC ALASKA OSLO CHÊNE CAVIAR	BLANC ALASKA OSLO CHÊNE CAVIAR CIMENT MAR ONIX MARMOL	
 <p>35 25.5 175</p>	U50783	Fond panneau + étagère	BLANC ALASKA OSLO CHÊNE CAVIAR	BLANC ALASKA OSLO CHÊNE CAVIAR CIMENT MAR ONIX MARMOL	
 <p>35 25.5 200</p>	U50784	Fond panneau + étagère	BLANC ALASKA OSLO CHÊNE CAVIAR	BLANC ALASKA OSLO CHÊNE CAVIAR CIMENT MAR ONIX MARMOL	

FOND PANNEAU + 2 ÉTAGÈRES

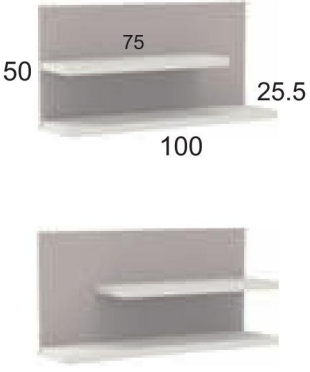
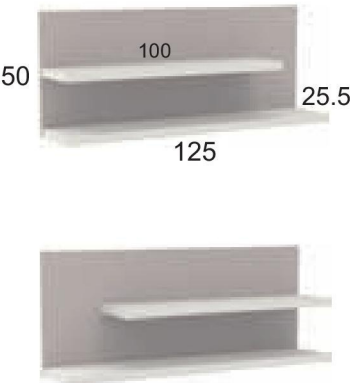
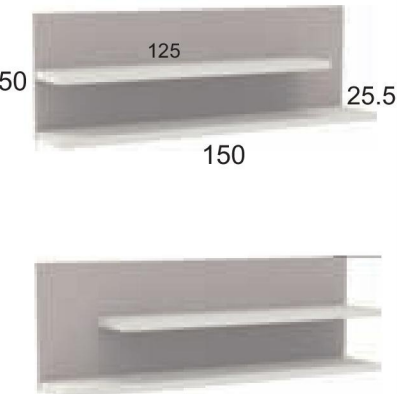
DIMENSIONS	REF.	DESCRIPTION	ÉTAGÈRE	FOND	POINTS
 <p>50 75 25.5 100</p>	U50787	Fond panneau + 2 étagères	BLANC ALASKA OSLO CHÊNE CAVIAR	BLANC ALASKA OSLO CHÊNE CAVIAR CIMENT MAR ONIX MARMOL	
 <p>50 100 25.5 125</p>	U50788	Fond panneau + 2 étagères	BLANC ALASKA OSLO CHÊNE CAVIAR	BLANC ALASKA OSLO CHÊNE CAVIAR CIMENT MAR ONIX MARMOL	
 <p>50 125 25.5 150</p>	U50789	Fond panneau + 2 étagères	BLANC ALASKA OSLO CHÊNE CAVIAR	BLANC ALASKA OSLO CHÊNE CAVIAR CIMENT MAR ONIX MARMOL	

ÉTAGÈRES VERTICALES

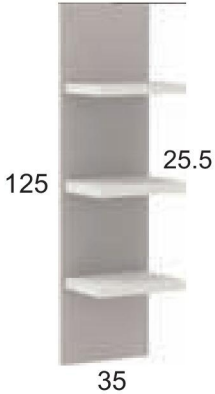
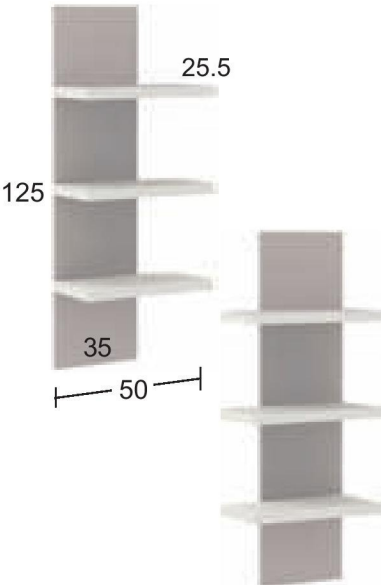
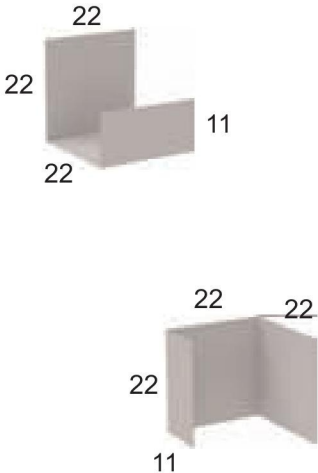
DIMENSIONS	REF.	DESCRIPTION	ÉTAGÈRE	FOND	POINTS
	U50779	Étagère verticale 35	BLANC ALASKA OSLO CHÊNE CAVIAR	BLANC ALASKA OSLO CHÊNE CAVIAR CIMENT MAR ONIX MARMOL	
	U50778	Étagère verticale 50	BLANC ALASKA OSLO CHÊNE CAVIAR	BLANC ALASKA OSLO CHÊNE CAVIAR CIMENT MAR ONIX MARMOL	
	U50777	Étagère métallique		BLANC CIMENT MAR ONIX MARMOL	

BUFFETS

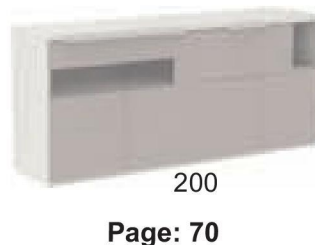
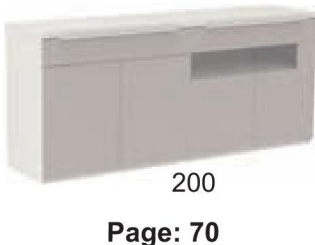
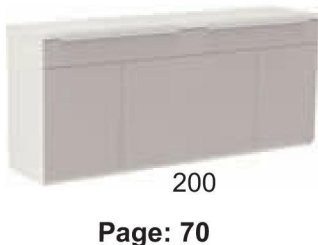
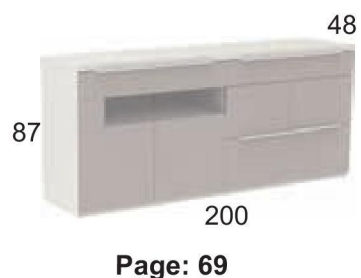
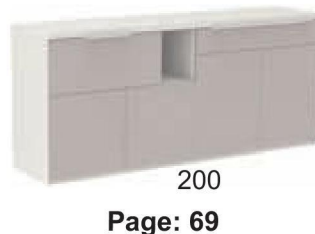
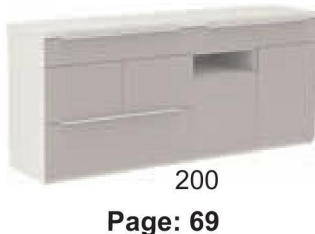
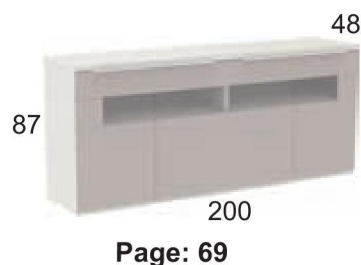
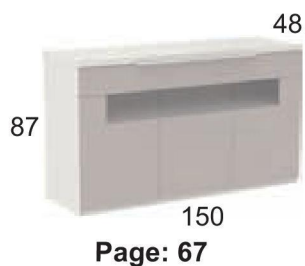
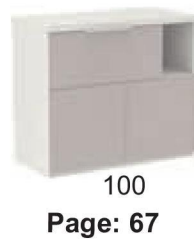
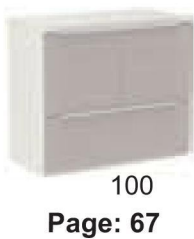
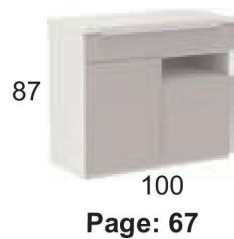
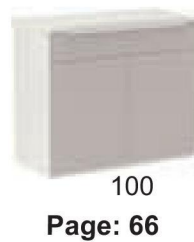
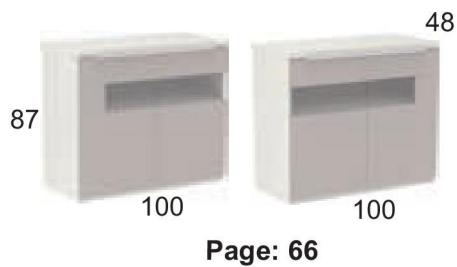

BUFFETS 100

Coulisses occultes avec amortisseurs

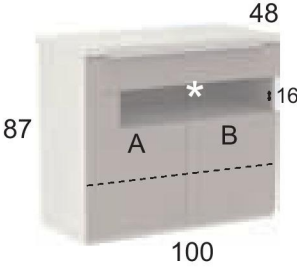
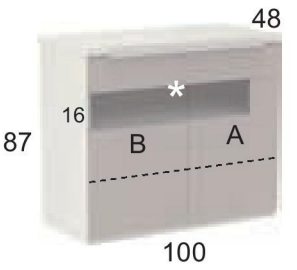
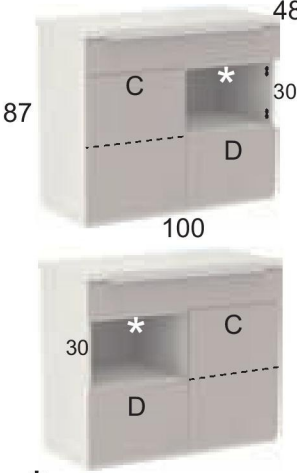
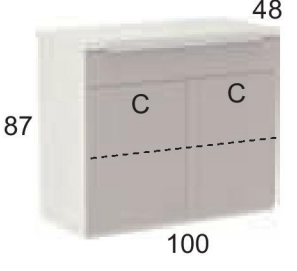
DIMENSIONS	REF.	DESCRIPTION	COULEUR STRUCT.	COUL. FAÇADE	POINTS
 <p>* Option illumination Pag. 60</p>	U50500	Buffet Verre Gauche	BLANC ALASKA OSLO CHÊNE CAVIAR	BLANC ALASKA OSLO CHÊNE CAVIAR CIMENT MAR ONIX	
 <p>* Option illumination Pag. 60</p>	U50501	Buffet Verre Droite			
 <p>* Option illumination Pag. 60</p>	U50510	Buffet niche Gauche - Droite	BLANC ALASKA OSLO CHÊNE CAVIAR	BLANC ALASKA OSLO CHÊNE CAVIAR CIMENT MAR ONIX	
	U50511	Buffet portes	BLANC ALASKA OSLO CHÊNE CAVIAR	BLANC ALASKA OSLO CHÊNE CAVIAR CIMENT MAR ONIX	

BUFFETS 100

Coulisses occultes avec amortisseurs

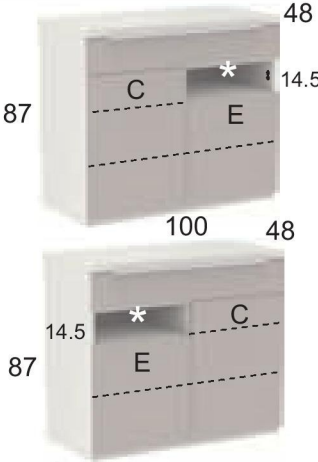
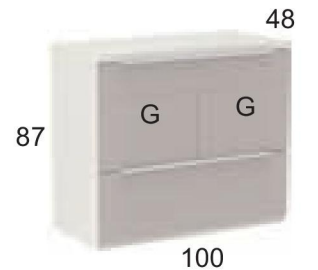
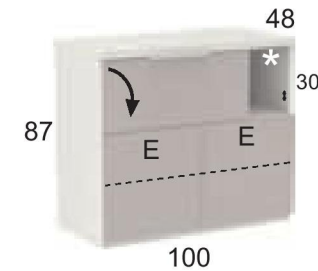
DIMENSIONS	REF.	DESCRIPTION	COULEUR STRUCT.	COUL. FACADE	POINTS
 <p>* Option illumination Pag. 60</p>	U50513	Buffet petite niche Gauche - Droite	BLANC ALASKA OSLO CHÊNE CAVIAR	BLANC ALASKA OSLO CHÊNE CAVIAR CIMENT MAR ONIX	
	U50514	Buffet container	BLANC ALASKA OSLO CHÊNE CAVIAR	BLANC ALASKA OSLO CHÊNE CAVIAR CIMENT MAR ONIX	
 <p>* Option illumination Pag. 60</p>	U50512	Buffet pte. abattante	BLANC ALASKA OSLO CHÊNE CAVIAR	BLANC ALASKA OSLO CHÊNE CAVIAR CIMENT MAR ONIX	

BUFFETS 150

Coulisses occultes avec amortisseurs

 <p>* Option illumination Pag. 60</p>	U50502	Buffet portes verre Verre fumé	BLANC ALASKA OSLO CHÊNE CAVIAR	BLANC ALASKA OSLO CHÊNE CAVIAR CIMENT MAR ONIX	
--	---------------	---------------------------------------	--	---	--

BUFFETS 150

Coulisses occultes avec amortisseurs

DIMENSIONS	REF.	DESCRIPTION	COULEUR STRUCT.	COUL. FAÇADE	POINTS
<p>87 48 14.5 * C E E 150</p> <p>* Option illumination Pag. 60</p>	U50520	Buffet petite niche	BLANC ALASKA OSLO CHÊNE CAVIAR	BLANC ALASKA OSLO CHÊNE CAVIAR CIMENT MAR ONIX	
<p>87 48 30 * G F 150</p> <p>* Option illumination Pag. 60</p>	U50524	Buffet container	BLANC ALASKA OSLO CHÊNE CAVIAR	BLANC ALASKA OSLO CHÊNE CAVIAR CIMENT MAR ONIX	
<p>87 48 G * 30 C 150</p> <p>* Option illumination Pag. 60</p>	U50522	Buffet container	BLANC ALASKA OSLO CHÊNE CAVIAR	BLANC ALASKA OSLO CHÊNE CAVIAR CIMENT MAR ONIX	
<p>87 48 F C * 30 G 150</p> <p>* Option illumination Pag. 60</p>	U50523	Buffet niche	BLANC ALASKA OSLO CHÊNE CAVIAR	BLANC ALASKA OSLO CHÊNE CAVIAR CIMENT MAR ONIX	
<p>87 48 F E E 150</p>	U50521	Buffet pte. abattante	BLANC ALASKA OSLO CHÊNE CAVIAR	BLANC ALASKA OSLO CHÊNE CAVIAR CIMENT MAR ONIX	

BUFFETS 200

Coulisses occultes avec amortisseurs

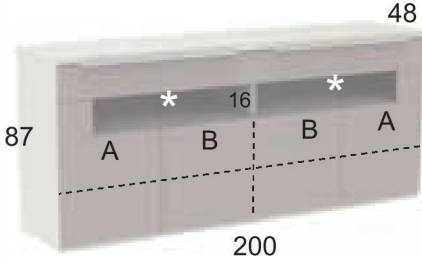
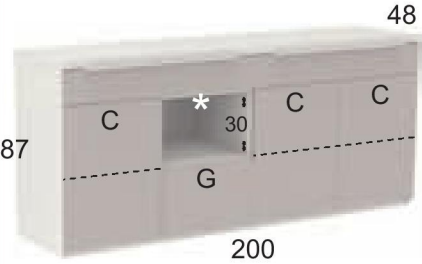
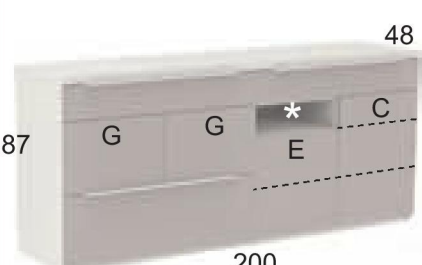
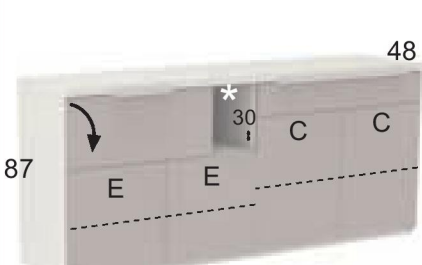
DIMENSIONS	REF.	DESCRIPTION	COULEUR STRUCT.	COUL. FAÇADE	POINTS
 <p>* Option illumination Pag. 60</p>	U50503	Buffet portes verre Verre fumé	BLANC ALASKA OSLO CHÊNE CAVIAR	BLANC ALASKA OSLO CHÊNE CAVIAR CIMENT MAR ONIX	
 <p>* Option illumination Pag. 60</p>	U50580	Buffet niche + portes	BLANC ALASKA OSLO CHÊNE CAVIAR	BLANC ALASKA OSLO CHÊNE CAVIAR CIMENT MAR ONIX	
 <p>* Option illumination Pag. 60</p>	U50581	Buffet petite niche + cont.	BLANC ALASKA OSLO CHÊNE CAVIAR	BLANC ALASKA OSLO CHÊNE CAVIAR CIMENT MAR ONIX	
 <p>* Option illumination Pag. 60</p>	U50582	Buffet pte abatt. + portes	BLANC ALASKA OSLO CHÊNE CAVIAR	BLANC ALASKA OSLO CHÊNE CAVIAR CIMENT MAR ONIX	

Note : Découpes SPÉCIALES page 3

Définir la couleur de la poignée (par défaut couleur alu) 69

BUFFETS 200

Coulisses occultes avec amortisseurs

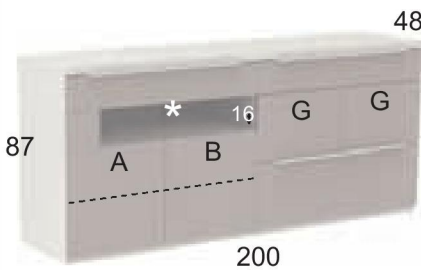
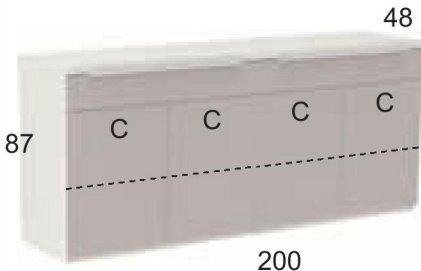
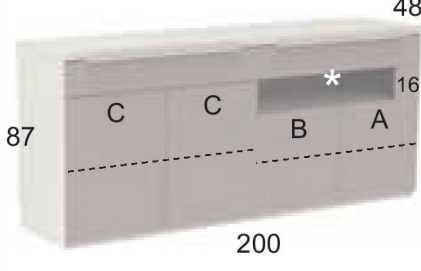
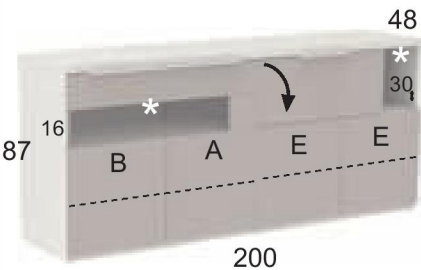
DIMENSIONS	REF.	DESCRIPTION	COULEUR STRUCT.	COUL. FAÇADE	POINTS
 <p>87 48 * 16 G G A B 200</p> <p>* Option illumination Pag. 60</p>	U50583	Buffet portes verre / cont. Verre fumé	BLANC ALASKA OSLO CHÊNE CAVIAR	BLANC ALASKA OSLO CHÊNE CAVIAR CIMENT MAR ONIX	
 <p>87 48 C C C C 200</p>	U50584	Buffet portes + portes	BLANC ALASKA OSLO CHÊNE CAVIAR	BLANC ALASKA OSLO CHÊNE CAVIAR CIMENT MAR ONIX	
 <p>87 48 C C * 16 B A 200</p> <p>* Option illumination Pag. 60</p>	U50585	Buffet portes + ptes verre Verre fumé	BLANC ALASKA OSLO CHÊNE CAVIAR	BLANC ALASKA OSLO CHÊNE CAVIAR CIMENT MAR ONIX	
 <p>87 48 * 30 16 * B A E E 200</p> <p>* Option illumination Pag. 60</p>	U50586	Buffet ptes verre + pte abatt. Verre fumé	BLANC ALASKA OSLO CHÊNE CAVIAR	BLANC ALASKA OSLO CHÊNE CAVIAR CIMENT MAR ONIX	

PLUS DE BUFFETS EN 200 ET 250, SECTION BUFFET MODULABLES PAG. 33 à 36

TABLES SALLE À MANGER

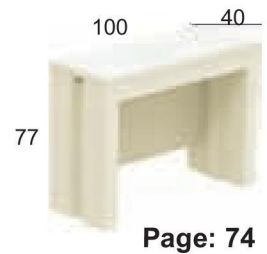
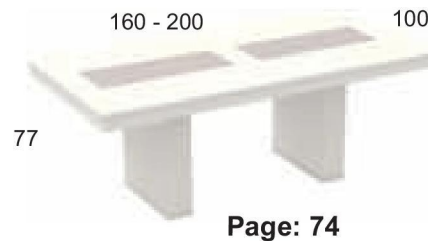
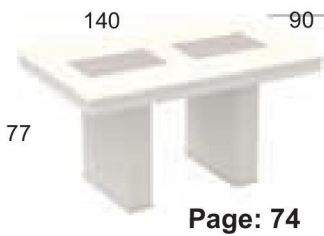
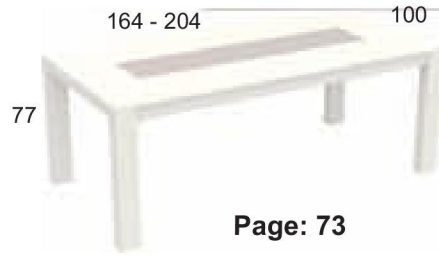
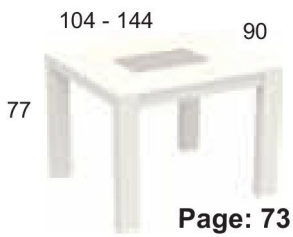
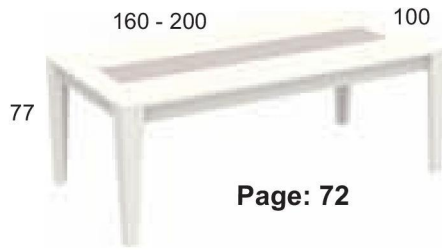
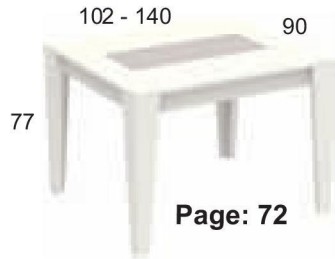

CHAISES



Page: 75

TABLES BASSES

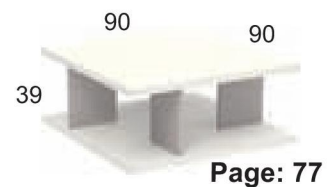
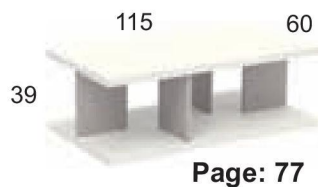
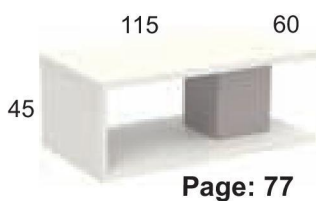
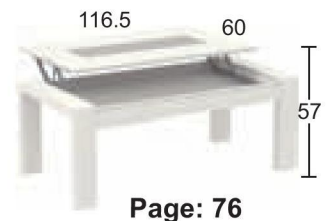
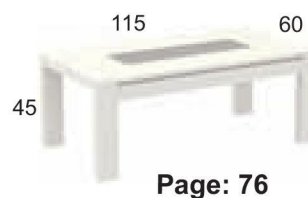
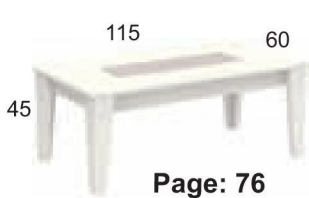

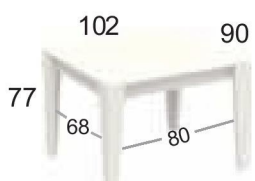
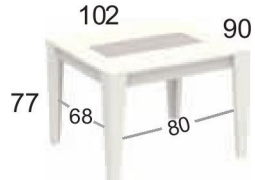
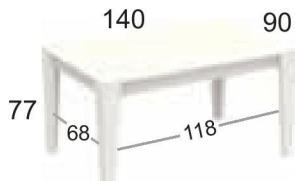
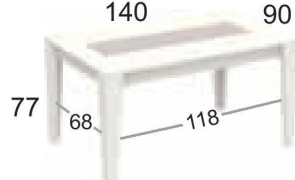
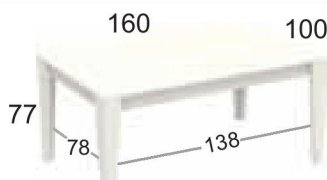
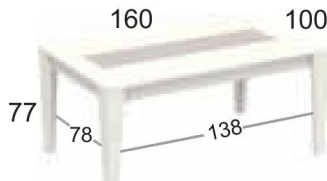
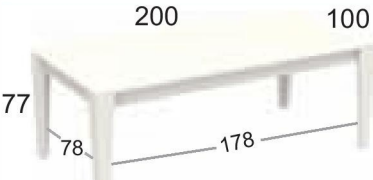
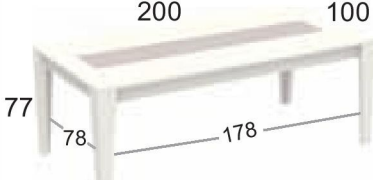

TABLES
CHAISES

TABLES SALLE À MANGER "A"

DIMENSIONS	REF.	DESCRIPTION	COULEUR	COULEUR DESSUS	POINTS
  PAS DE DÉCOUPE EN LARGEUR POSSIBLE	U50901	Table "A" de 102 x 90 Dessus panneau	BLANC ALASKA OSLO CHÊNE CAVIAR	BLANC ALASKA OSLO CHÊNE CAVIAR MARMOL	
	U50902	Table "A" de 102 x 90 Dessus Verre		COULEUR VERRE	
  PAS DE DÉCOUPE EN LARGEUR POSSIBLE	U50903	Table "A" de 140 x 90 Dessus panneau	BLANC ALASKA OSLO CHÊNE CAVIAR	BLANC ALASKA OSLO CHÊNE CAVIAR MARMOL	
	U50904	Table "A" de 140 x 90 Dessus Verre		COULEUR VERRE	
  RECOUPE MAXI A 90 CM DE LARGE	U50905	Table "A" de 160 x 100 Dessus panneau	BLANC ALASKA OSLO CHÊNE CAVIAR	BLANC ALASKA OSLO CHÊNE CAVIAR MARMOL	
	U50906	Table "A" de 160 x 100 Dessus Verre		COULEUR VERRE	
  RECOUPE MAXI A 90 CM DE LARGE	U50907	Table "A" de 200 x 100 Dessus panneau	BLANC ALASKA OSLO CHÊNE CAVIAR	BLANC ALASKA OSLO CHÊNE CAVIAR MARMOL	
	U50908	Table "A" de 200 x 100 Dessus Verre		COULEUR VERRE	

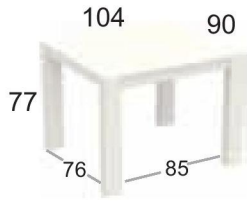
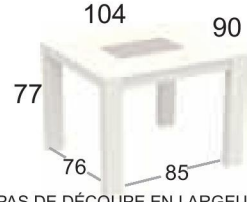
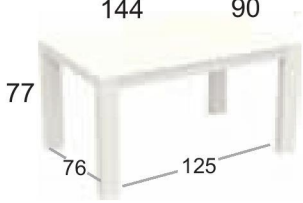



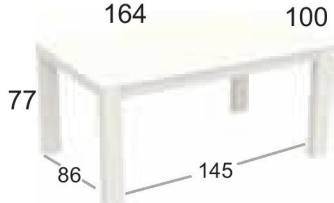
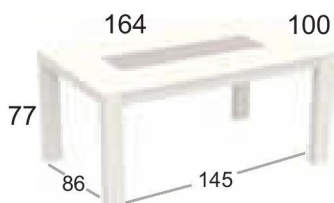
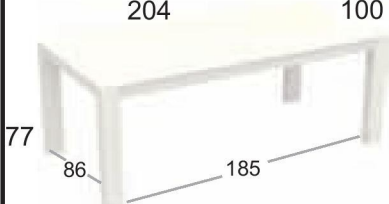
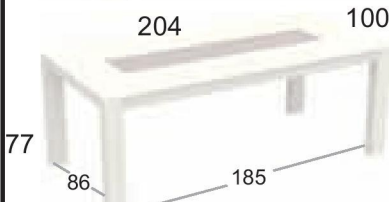



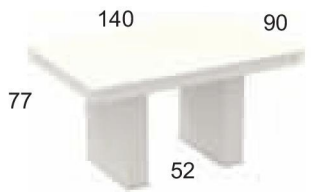

TABLES SALLE À MANGER "B"

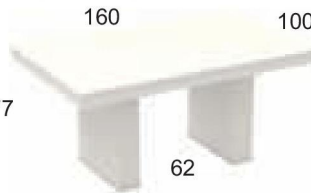
DIMENSIONS	REF.	DESCRIPTION	COULEUR	COULEUR DESSUS	POINTS
 <p>104 90 77 76 85</p>	U50921 U50922	Table "B" de 104 x 90 Dessus panneau	BLANC ALASKA OSLO CHÊNE CAVIAR	BLANC ALASKA OSLO CHÊNE CAVIAR MARMOL	
		Table "B" de 104 x 90 Dessus Verre		 <p>104 90 77 76 85</p> PAS DE DÉCOUPE EN LARGEUR POSSIBLE	
 <p>144 90 77 76 125</p>	U50923 U50924	Table "B" de 144 x 90 Dessus panneau	BLANC ALASKA OSLO CHÊNE CAVIAR	BLANC ALASKA OSLO CHÊNE CAVIAR MARMOL	
		Table "B" de 144 x 90 Dessus Verre		 <p>144 90 77 76 125</p> PAS DE DÉCOUPE EN LARGEUR POSSIBLE	

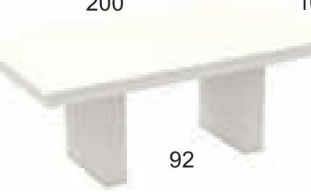

 <p>164 100 77 86 145</p>	U50925 U50926	Table "B" de 164 x 100 Dessus panneau	BLANC ALASKA OSLO CHÊNE CAVIAR	BLANC ALASKA OSLO CHÊNE CAVIAR MARMOL	
		Table "B" de 164 x 100 Dessus Verre		 <p>164 100 77 86 145</p> RECOUPE MAXI A 90 CM DE LARGE	
 <p>204 100 77 86 185</p>	U50927 U50928	Table "B" de 204 x 100 Dessus panneau	BLANC ALASKA OSLO CHÊNE CAVIAR	BLANC ALASKA OSLO CHÊNE CAVIAR MARMOL	
		Table "B" de 204 x 100 Dessus Verre		 <p>204 100 77 86 185</p> RECOUPE MAXI A 90 CM DE LARGE	

Note : Découpes SPÉCIALES page: 77

TABLES SALLE À MANGER "D"





DIMENSIONS	REF.	DESCRIPTION	COULEUR PIEDS	COULEUR DESSUS	POINTS
 <p>77</p> <p>140 90</p> <p>52</p>	U50941	Table "D" de 140 Dessus panneau	BLANC ALASKA OSLO	BLANC ALASKA OSLO CHÊNE CAVIAR MARMOL	
 <p>77</p> <p>140 90</p> <p>52</p> <p>PAS DE DÉCOUPE EN LARGEUR POSSIBLE</p>		Table "D" de 140 Dessus Verre		CHÊNE CAVIAR MARMOL	
 <p>77</p> <p>160 100</p> <p>62</p>	U50943	Table "D" de 160 Dessus panneau	BLANC ALASKA OSLO	BLANC ALASKA OSLO CHÊNE CAVIAR MARMOL	
 <p>77</p> <p>160 100</p> <p>62</p> <p>RECOUPE MAXI A 90 CM DE LARGE</p>		Table "D" de 160 Dessus Verre		CHÊNE CAVIAR MARMOL	
 <p>77</p> <p>200 100</p> <p>92</p>	U50945	Table "D" de 200 Dessus panneau	BLANC ALASKA OSLO	BLANC ALASKA OSLO CHÊNE CAVIAR MARMOL	
 <p>77</p> <p>200 100</p> <p>92</p> <p>RECOUPE MAXI A 90 CM DE LARGE</p>		Table "D" de 200 Dessus Verre		CHÊNE CAVIAR MARMOL	
 <p>77</p> <p>100 40</p> <p>AUCUNE DÉCOUPE SPÉCIALE POSSIBLE</p>	U50960	Table console extensible Dessus panneau		BLANC ALASKA OSLO CHÊNE CAVIAR	
		<p>Ouverte:</p>  <p>90 x 100</p>  <p>190 x 100</p>  <p>140 x 100</p>  <p>240 x 100</p>			

CHAISES

DIMENSIONS	REF.	DESCRIPTION	COULEUR STRUCT.	COULEUR TISSU	POINTS
 <p>108 64 50 45</p> <p>Possibilité de commander la chaise prête à tapisser</p>	U50891	Chaise tapissée MOD. 200	BLANC ALASKA OSLO CHÊNE CAVIAR	SERIE WESTER DE FROCA Page: 95	
 <p>94 51 50 46</p>	U50893	Chaise tapissée MOD. 220	BLANC ALASKA OSLO CHÊNE CAVIAR	SERIE WESTER DE FROCA Page: 95	
 <p>89 50 49</p> <p>Possibilité de commander la chaise prête à tapisser</p>	U50895	Chaise tapissée MOD. 250	BLANC ALASKA OSLO CHÊNE CAVIAR	SERIE WESTER DE FROCA Page: 95	
 <p>89 50 49</p>	U50898	Chaise NON tapissée MOD. 270	COULEUR ASSISE BLANC ALASKA OSLO CHÊNE CAVIAR CIMENT ONIX MAR	COULEUR PIEDS BLANC ALASKA OSLO CHÊNE CAVIAR	

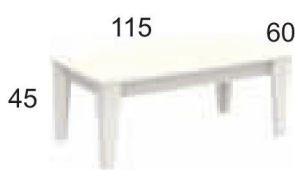
Note: Tissu à choisir entre tous les tissus de la serie WESTER de FROCA

TABLES BASSES

DIMENSIONS	REF.	DESCRIPTION	COULEUR	COULEUR DESSUS	POINTS
 <p>115 60 45</p>	U50986	Table basse "A" fixe Dessus panneau	BLANC ALASKA OSLO CHÊNE CAVIAR	BLANC ALASKA OSLO CHÊNE CAVIAR MARMOL	
	U50987	Table basse "A" fixe Dessus verre	OSLO CHÊNE CAVIAR	COULEUR VERRE BLANC ONIX MAR	
 <p>115 *60 57 45</p>	U50988	Table basse "A" relevable Dessus panneau	BLANC ALASKA OSLO CHÊNE CAVIAR	BLANC ALASKA OSLO CHÊNE CAVIAR MARMOL	
	U50989	Table basse "A" relevable Dessus verre	OSLO CHÊNE CAVIAR	COULEUR VERRE BLANC ONIX MAR	
* Recoupe maxi à 50 cm de large					
 <p>115 60 45</p>	U50980	Table basse "B" fixe Dessus panneau	BLANC ALASKA OSLO CHÊNE CAVIAR	BLANC ALASKA OSLO CHÊNE CAVIAR MARMOL	
	U50981	Table basse "B" fixe Dessus verre	OSLO CHÊNE CAVIAR	COULEUR VERRE BLANC ONIX MAR	
 <p>116.5 *60 57 45</p>	U50982	Table basse "B" relevable Dessus panneau	BLANC ALASKA OSLO CHÊNE CAVIAR	BLANC ALASKA OSLO CHÊNE CAVIAR MARMOL	
	U50983	Table basse "B" relevable Dessus verre	OSLO CHÊNE CAVIAR	COULEUR VERRE BLANC ONIX MAR	
* Recoupe maxi à 50 cm de large					

TABLES BASSES

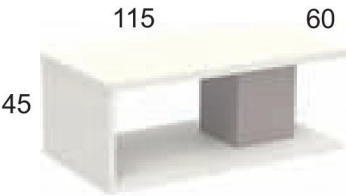
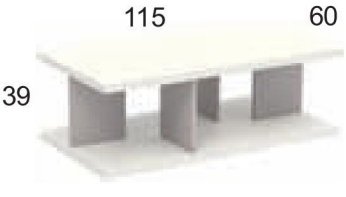
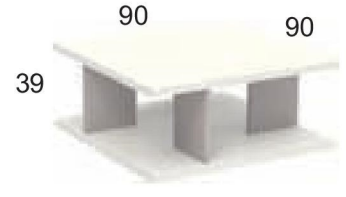
DIMENSIONS	REF.	DESCRIPTION	COULEUR	PIED CENTRAL	POINTS
 <p>115 60 45</p>	U50970	Table basse « cube »	BLANC ALASKA OSLO CHÊNE CAVIAR	BLANC ALASKA OSLO CHÊNE CAVIAR CIMENT ONIX MAR MARMOL	
 <p>115 60 39</p>	U50979	Table basse rectangulaire	BLANC ALASKA OSLO CHÊNE CAVIAR	BLANC ALASKA OSLO CHÊNE CAVIAR CIMENT ONIX MAR MARMOL	
 <p>90 90 39</p>	U50975	Table basse carrée	BLANC ALASKA OSLO CHÊNE CAVIAR	BLANC ALASKA OSLO CHÊNE CAVIAR CIMENT ONIX MAR MARMOL	

Note: Découpe de tables à une dimension plus petite (longueur, largeur ou hauteur) : +10%
 Combinaison de 2 découpes : +15%
 Combinaison de 3 découpes : +20%.
 Les verres des tables découpées maintiendront leur dimension originale.